

QUADRAMOBILE

SUPPORTED
FULL DEPTH
SHELF

Expandable Modular Mobile Systems



 MONTEL



Phone : **321-777-0464**
Fax : **312-777-3539**
Toll Free : **800-772-7562**
E-Mail : aetnagsa@montel.com
Web : www.aetnastak.com

 **MONTEL
AETNASTAK**

Kits

Starter section single face shelving - fixed _____ **QM/3-QM/5**
 Adder section single face shelving - fixed _____ **QM/6-QM/8**
 Starter section double face full depth shelving - fixed _____ **QM/9-QM/11**
 Adder section double face full depth shelving - fixed _____ **QM/12-QM/14**
 Starter section single face shelving - mobile _____ **QM/15-QM/17**
 Adder section single face shelving - mobile _____ **QM/18-QM/20**
 Starter section double face full depth shelving - mobile _____ **QM/21-QM/23**
 Adder section double face full depth shelving - mobile _____ **QM/24-QM/26**

Floors

Modular floor _____ **QM/27**

Options

Options _____ **QM/28**

Panels

Steel back panel _____ **QM/29**
 Steel front panel fixed section - single face _____ **QM/30**
 Steel front panel fixed section - double face _____ **QM/31**
 Steel front panel mobile section - single face _____ **QM/32**
 Steel front panel mobile section - double face _____ **QM/33**

Carriages

Carriage fixed section - starter single face _____ **QM/34**
 Carriage fixed section - adder single face _____ **QM/35**
 Carriage fixed section - starter double face _____ **QM/36**
 Carriage fixed section - adder double face _____ **QM/37**
 Carriage mobile section - starter single face _____ **QM/38**
 Carriage mobile section - adder single face _____ **QM/39**
 Carriage mobile section - starter double face _____ **QM/40**
 Carriage mobile section - adder double face _____ **QM/41**

Shelves

Plain supported shelf assembly kit 22 gauge _____ **QM/42-QM/43**
 Slotted supported shelf assembly kit 22 gauge _____ **QM/44-QM/45**
 Plain supported box shelf assembly kit 22 gauge _____ **QM/46-QM/47**
 Slotted supported box shelf assembly kit 22 gauge _____ **QM/48-QM/49**

Accessories

Divider _____ **QM/50**
 Sliding reference shelf _____ **QM/50-QM/51**
 Media tray _____ **QM/51**
 Findable book support _____ **QM/51**
 Front stop _____ **QM/52**
 Label holder _____ **QM/52**
 Range finder _____ **QM/52**
 Card holder _____ **QM/52**
 Doors _____ **QM/53**

QUADRAMOBILE SMARTSHELF FULL DEPTH

Fixed section 76" high

QUADRAMOBILE

| | CODE # | W | D | H | lbs | \$ |
|---|------------------|-------|----|----|------|----------|
| | | Frame | | | | |
| STARTER SECTION SINGLE FACE SHELVING - FIXED | | | | | | |
| 30" WIDE | QMSF.FSE763012 | 30 | 12 | 76 | 72.9 | \$710.00 |
| | QMSF.FSE763013 | 30 | 13 | 76 | 75.5 | \$716.00 |
| | QMSF.FSE763015 | 30 | 15 | 76 | 80.5 | \$728.00 |
| | QMSF.FSE763016 | 30 | 16 | 76 | 83.0 | \$733.00 |
| 36" WIDE | QMSF.FSE763612** | 36 | 12 | 76 | 75.6 | \$715.00 |
| | QMSF.FSE763613 | 36 | 13 | 76 | 78.2 | \$722.00 |
| | QMSF.FSE763615** | 36 | 15 | 76 | 83.4 | \$733.00 |
| | QMSF.FSE763616 | 36 | 16 | 76 | 86.0 | \$739.00 |
| 39 3/8" WIDE | QMSF.FSE763912 | 39 | 12 | 76 | 77.1 | \$720.00 |
| | QMSF.FSE763913 | 39 | 13 | 76 | 79.8 | \$725.00 |
| | QMSF.FSE763915 | 39 | 15 | 76 | 85.0 | \$738.00 |
| | QMSF.FSE763916 | 39 | 16 | 76 | 87.6 | \$743.00 |
| 42" WIDE | QMSF.FSE764212** | 42 | 12 | 76 | 78.3 | \$722.00 |
| | QMSF.FSE764213 | 42 | 13 | 76 | 81.0 | \$727.00 |
| | QMSF.FSE764215** | 42 | 15 | 76 | 86.2 | \$740.00 |
| | QMSF.FSE764216 | 42 | 16 | 76 | 88.9 | \$746.00 |
| 48" WIDE | QMSF.FSE764812 | 48 | 12 | 76 | 81.0 | \$728.00 |
| | QMSF.FSE764813 | 48 | 13 | 76 | 83.7 | \$735.00 |
| | QMSF.FSE764815 | 48 | 15 | 76 | 89.1 | \$747.00 |
| | QMSF.FSE764816 | 48 | 16 | 76 | 91.8 | \$753.00 |

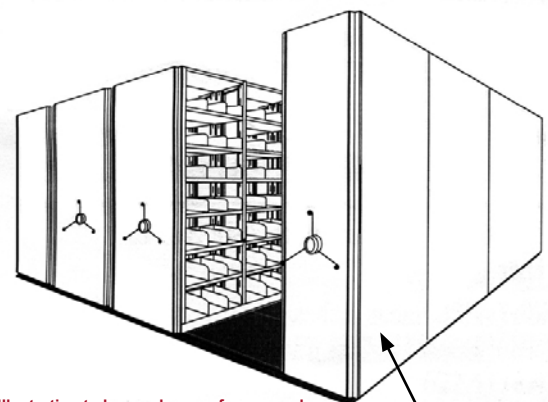

Illustration to be used as a reference only

Shelves and modular floor not included (see page **QM/42-QM/49** for shelves and see page **QM/27** for floor)

- Components for a single face **starter** section
- 1 single carriage with bumper
 - 1 front panel
 - 2 upright frames
 - 1 canopy top

Notes :

- Aluminium extrusions not available
- Add 5" high for the overall height
- Maximum length = 12 feet
- ** Available on QuickShip program (see **QuickShip** tab)



Issued 06-01-2005

QM/3

QUADRAMOBILE SMARTSHELF FULL DEPTH

Fixed section 85" high

QUADRAMOBILE

| | CODE # | W | D | H | lbs | \$ |
|---|------------------|-------|----|----|------|----------|
| | | Frame | | | | |
| STARTER SECTION SINGLE FACE SHELVING - FIXED | | | | | | |
| 30" WIDE | QMSF.FSE853012 | 30 | 12 | 85 | 77.7 | \$721.00 |
| | QMSF.FSE853013 | 30 | 13 | 85 | 80.3 | \$727.00 |
| | QMSF.FSE853015 | 30 | 15 | 85 | 85.6 | \$739.00 |
| | QMSF.FSE853016 | 30 | 16 | 85 | 88.2 | \$745.00 |
| 36" WIDE | QMSF.FSE853612** | 36 | 12 | 85 | 80.4 | \$725.00 |
| | QMSF.FSE853613 | 36 | 13 | 85 | 83.1 | \$733.00 |
| | QMSF.FSE853615** | 36 | 15 | 85 | 88.4 | \$745.00 |
| | QMSF.FSE853616 | 36 | 16 | 85 | 91.1 | \$751.00 |
| 39 3/8" WIDE | QMSF.FSE853912 | 39 | 12 | 85 | 81.9 | \$730.00 |
| | QMSF.FSE853913 | 39 | 13 | 85 | 84.6 | \$736.00 |
| | QMSF.FSE853915 | 39 | 15 | 85 | 90.0 | \$749.00 |
| | QMSF.FSE853916 | 39 | 16 | 85 | 92.7 | \$754.00 |
| 42" WIDE | QMSF.FSE854212** | 42 | 12 | 85 | 83.1 | \$733.00 |
| | QMSF.FSE854213 | 42 | 13 | 85 | 85.8 | \$738.00 |
| | QMSF.FSE854215** | 42 | 15 | 85 | 91.3 | \$751.00 |
| | QMSF.FSE854216 | 42 | 16 | 85 | 94.0 | \$758.00 |
| 48" WIDE | QMSF.FSE854812 | 48 | 12 | 85 | 85.8 | \$739.00 |
| | QMSF.FSE854813 | 48 | 13 | 85 | 88.6 | \$746.00 |
| | QMSF.FSE854815 | 48 | 15 | 85 | 94.1 | \$758.00 |
| | QMSF.FSE854816 | 48 | 16 | 85 | 96.9 | \$764.00 |

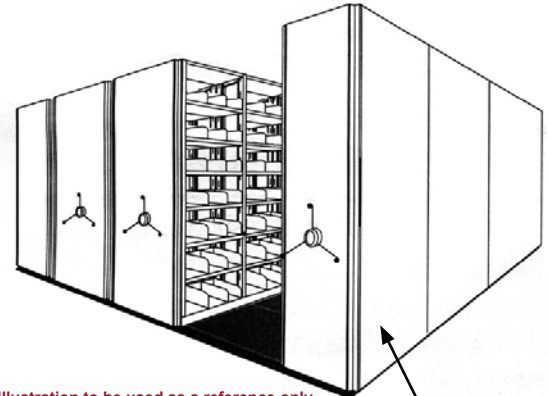

Illustration to be used as a reference only

Shelves and modular floor not included (see page **QM/42-QM/49** for shelves and see page **QM/27** for floor)

STARTER

Components for a single face **starter** section

- 1 single carriage with bumper
- 1 front panel
- 2 upright frames
- 1 canopy top

Notes :

- Aluminium extrusions not available
- Add 5" high for the overall height
- Maximum length = 12 feet
- ** Available on QuickShip program (see **QuickShip** tab)

QM/4

Issued 06-01-2005



QUADRAMOBILE SMARTSHELF FULL DEPTH

Fixed section 88" high

QUADRAMOBILE

| | CODE # | W | D | H | lbs | \$ |
|---|------------------|-------|----|----|------|----------|
| | | Frame | | | | |
| STARTER SECTION SINGLE FACE SHELVING - FIXED | | | | | | |
| 30" WIDE | QMSF.FSE883012 | 30 | 12 | 88 | 79.3 | \$724.00 |
| | QMSF.FSE883013 | 30 | 13 | 88 | 81.9 | \$730.00 |
| | QMSF.FSE883015 | 30 | 15 | 88 | 87.3 | \$743.00 |
| | QMSF.FSE883016 | 30 | 16 | 88 | 89.9 | \$748.00 |
| 36" WIDE | QMSF.FSE883612** | 36 | 12 | 88 | 82.0 | \$730.00 |
| | QMSF.FSE883613 | 36 | 13 | 88 | 84.7 | \$736.00 |
| | QMSF.FSE883615** | 36 | 15 | 88 | 90.1 | \$748.00 |
| | QMSF.FSE883616 | 36 | 16 | 88 | 92.8 | \$755.00 |
| 39 3/8" WIDE | QMSF.FSE883912 | 39 | 12 | 88 | 83.5 | \$734.00 |
| | QMSF.FSE883913 | 39 | 13 | 88 | 86.2 | \$739.00 |
| | QMSF.FSE883915 | 39 | 15 | 88 | 91.7 | \$753.00 |
| | QMSF.FSE883916 | 39 | 16 | 88 | 94.4 | \$758.00 |
| 42" WIDE | QMSF.FSE884212** | 42 | 12 | 88 | 84.7 | \$736.00 |
| | QMSF.FSE884213 | 42 | 13 | 88 | 87.4 | \$742.00 |
| | QMSF.FSE884215** | 42 | 15 | 88 | 93.0 | \$755.00 |
| | QMSF.FSE884216 | 42 | 16 | 88 | 95.7 | \$762.00 |
| 48" WIDE | QMSF.FSE884812 | 48 | 12 | 88 | 87.4 | \$743.00 |
| | QMSF.FSE884813 | 48 | 13 | 88 | 90.2 | \$749.00 |
| | QMSF.FSE884815 | 48 | 15 | 88 | 95.8 | \$762.00 |
| | QMSF.FSE884816 | 48 | 16 | 88 | 98.6 | \$768.00 |

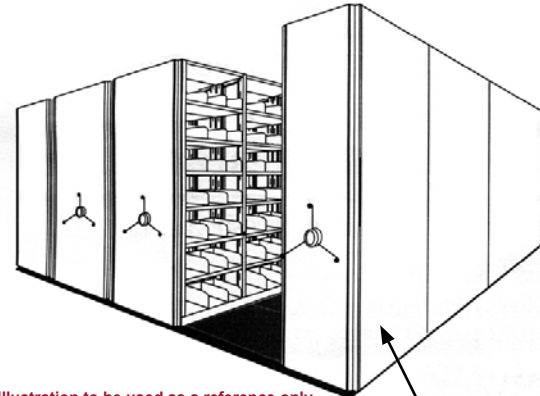

Illustration to be used as a reference only

Shelves and modular floor not included (see page [QM/42-QM/49](#) for shelves and see page [QM/27](#) for floor)

STARTER

Components for a single face **starter** section

- 1 single carriage with bumper
- 1 front panel
- 2 upright frames
- 1 canopy top

Notes :

- Aluminium extrusions not available
- Add 5" high for the overall height
- Maximum length = 12 feet
- ** Available on QuickShip program (see [QuickShip](#) tab)

QUADRAMOBILE SMARTSHELF FULL DEPTH

Fixed section 76" high

QUADRAMOBILE

| CODE # | W | D | H | lbs | \$ | |
|---|------------------|----|----|-----|------|----------|
| | Frame | | | | | |
| ADDER SECTION SINGLE FACE SHELVING - FIXED | | | | | | |
| 30" WIDE | QMSF.FAE763012 | 30 | 12 | 76 | 36.7 | \$379.00 |
| | QMSF.FAE763013 | 30 | 13 | 76 | 37.8 | \$382.00 |
| | QMSF.FAE763015 | 30 | 15 | 76 | 40.1 | \$387.00 |
| | QMSF.FAE763016 | 30 | 16 | 76 | 41.2 | \$389.00 |
| 36" WIDE | QMSF.FAE763612** | 36 | 12 | 76 | 38.4 | \$384.00 |
| | QMSF.FAE763613 | 36 | 13 | 76 | 40.6 | \$387.00 |
| | QMSF.FAE763615** | 36 | 15 | 76 | 41.9 | \$392.00 |
| | QMSF.FAE763616 | 36 | 16 | 76 | 44.1 | \$394.00 |
| 39 3/8" WIDE | QMSF.FAE763912 | 39 | 12 | 76 | 40.9 | \$387.00 |
| | QMSF.FAE763913 | 39 | 13 | 76 | 42.1 | \$390.00 |
| | QMSF.FAE763915 | 39 | 15 | 76 | 44.6 | \$395.00 |
| | QMSF.FAE763916 | 39 | 16 | 76 | 45.7 | \$398.00 |
| 42" WIDE | QMSF.FAE764212** | 42 | 12 | 76 | 41.1 | \$390.00 |
| | QMSF.FAE764213 | 42 | 13 | 76 | 43.3 | \$392.00 |
| | QMSF.FAE764215** | 42 | 15 | 76 | 44.8 | \$398.00 |
| | QMSF.FAE764216 | 42 | 16 | 76 | 47.0 | \$402.00 |
| 48" WIDE | QMSF.FAE764812 | 48 | 12 | 76 | 44.8 | \$398.00 |
| | QMSF.FAE764813 | 48 | 13 | 76 | 46.1 | \$401.00 |
| | QMSF.FAE764815 | 48 | 15 | 76 | 48.7 | \$405.00 |
| | QMSF.FAE764816 | 48 | 16 | 76 | 49.9 | \$408.00 |

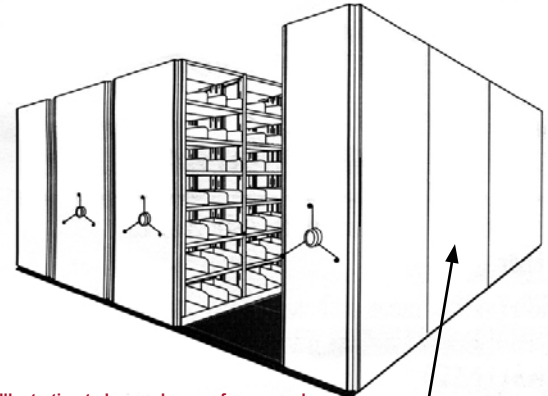

Illustration to be used as a reference only

Shelves and modular floor not included (see page **QM/42-QM/49** for shelves and see page **QM/27** for floor) **ADDER**

Components for a single face **adder** section

- 1 single carriage
- 1 upright frame
- 1 canopy top

Notes :

- Aluminium extrusions not available
- Add 5" high for the overall height
- Maximum length = 12 feet
- ** Available on QuickShip program (see **QuickShip** tab)

QM/6

Issued 06-01-2005



QUADRAMOBILE SMARTSHELF FULL DEPTH

Fixed section 85" high

QUADRAMOBILE

| | CODE # | W | D | H | lbs | \$ |
|---|------------------|-------|----|----|------|----------|
| | | Frame | | | | |
| ADDER SECTION SINGLE FACE SHELVING - FIXED | | | | | | |
| 30" WIDE | QMSF.FAE853012 | 30 | 12 | 85 | 38.3 | \$383.00 |
| | QMSF.FAE853013 | 30 | 13 | 85 | 39.4 | \$385.00 |
| | QMSF.FAE853015 | 30 | 15 | 85 | 41.7 | \$390.00 |
| | QMSF.FAE853016 | 30 | 16 | 85 | 42.8 | \$392.00 |
| 36" WIDE | QMSF.FAE853612** | 36 | 12 | 85 | 41.0 | \$388.00 |
| | QMSF.FAE853613 | 36 | 13 | 85 | 42.2 | \$390.00 |
| | QMSF.FAE853615** | 36 | 15 | 85 | 44.5 | \$395.00 |
| | QMSF.FAE853616 | 36 | 16 | 85 | 45.7 | \$398.00 |
| 39 3/8" WIDE | QMSF.FAE853912 | 39 | 12 | 85 | 42.5 | \$391.00 |
| | QMSF.FAE853913 | 39 | 13 | 85 | 43.7 | \$393.00 |
| | QMSF.FAE853915 | 39 | 15 | 85 | 46.1 | \$398.00 |
| | QMSF.FAE853916 | 39 | 16 | 85 | 47.3 | \$402.00 |
| 42" WIDE | QMSF.FAE854212** | 42 | 12 | 85 | 43.7 | \$393.00 |
| | QMSF.FAE854213 | 42 | 13 | 85 | 44.9 | \$396.00 |
| | QMSF.FAE854215** | 42 | 15 | 85 | 47.4 | \$402.00 |
| | QMSF.FAE854216 | 42 | 16 | 85 | 48.6 | \$405.00 |
| 48" WIDE | QMSF.FAE854812 | 48 | 12 | 85 | 46.4 | \$401.00 |
| | QMSF.FAE854813 | 48 | 13 | 85 | 47.7 | \$404.00 |
| | QMSF.FAE854815 | 48 | 15 | 85 | 50.2 | \$408.00 |
| | QMSF.FAE854816 | 48 | 16 | 85 | 51.5 | \$411.00 |

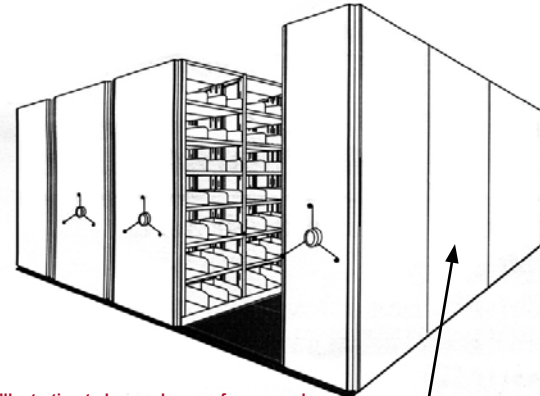

Illustration to be used as a reference only

Shelves and modular floor not included (see page **QM/42-QM/49** for shelves and see page **QM/27** for floor) **ADDER**

Components for a single face **adder** section

- 1 single carriage
- 1 upright frame
- 1 canopy top

Notes :

- Aluminium extrusions not available
- Add 5" high for the overall height
- Maximum length = 12 feet
- ** Available on QuickShip program (see **QuickShip** tab)



Issued 06-01-2005

QM/7

QUADRAMOBILE SMARTSHELF FULL DEPTH

Fixed section 88" high

QUADRAMOBILE

| | CODE # | W | D | H | lbs | \$ |
|---------------------|-------------------------|-------|----|----|------|-----------------|
| | | Frame | | | | |
| 30" WIDE | QMSF.FAE883012 | 30 | 12 | 88 | 38.8 | \$384.00 |
| | QMSF.FAE883013 | 30 | 13 | 88 | 39.9 | \$386.00 |
| | QMSF.FAE883015 | 30 | 15 | 88 | 42.2 | \$391.00 |
| | QMSF.FAE883016 | 30 | 16 | 88 | 43.3 | \$393.00 |
| 36" WIDE | QMSF.FAE883612** | 36 | 12 | 88 | 40.3 | \$389.00 |
| | QMSF.FAE883613 | 36 | 13 | 88 | 42.7 | \$391.00 |
| | QMSF.FAE883615** | 36 | 15 | 88 | 43.9 | \$397.00 |
| | QMSF.FAE883616 | 36 | 16 | 88 | 46.2 | \$399.00 |
| 39 3/8" WIDE | QMSF.FAE883912 | 39 | 12 | 88 | 42.8 | \$392.00 |
| | QMSF.FAE883913 | 39 | 13 | 88 | 44.2 | \$394.00 |
| | QMSF.FAE883915 | 39 | 15 | 88 | 46.0 | \$399.00 |
| | QMSF.FAE883916 | 39 | 16 | 88 | 47.8 | \$403.00 |
| 42" WIDE | QMSF.FAE884212** | 42 | 12 | 88 | 43.0 | \$395.00 |
| | QMSF.FAE884213 | 42 | 13 | 88 | 45.5 | \$397.00 |
| | QMSF.FAE884215** | 42 | 15 | 88 | 46.7 | \$403.00 |
| | QMSF.FAE884216 | 42 | 16 | 88 | 49.1 | \$407.00 |
| 48" WIDE | QMSF.FAE884812 | 48 | 12 | 88 | 46.9 | \$402.00 |
| | QMSF.FAE884813 | 48 | 13 | 88 | 48.2 | \$405.00 |
| | QMSF.FAE884815 | 48 | 15 | 88 | 50.8 | \$410.00 |
| | QMSF.FAE884816 | 48 | 16 | 88 | 52.0 | \$412.00 |

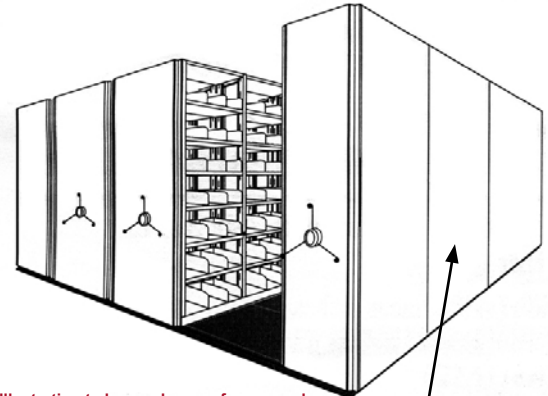

Illustration to be used as a reference only

Shelves and modular floor not included (see page **QM/42-QM/49** for shelves and see page **QM/27** for floor) **ADDER**

- Components for a single face **adder** section
- 1 single carriage
 - 1 upright frame
 - 1 canopy top

Notes :

- Aluminium extrusions not available
- Add 5" high for the overall height
- Maximum length = 12 feet
- ** Available on QuickShip program (see **QuickShip** tab)

QM/8

QUADRAMOBILE SMARTSHELF FULL DEPTH

Fixed section 76" high

QUADRAMOBILE

| | CODE # | W | D | H | lbs | \$ |
|--|----------------|-------|----|----|-------|----------|
| | | Frame | | | | |
| STARTER DOUBLE FACE FULL DEPTH SHELVING - FIXED | | | | | | |
| 30" WIDE | QMSF.FSE763024 | 30 | 24 | 76 | 100.3 | \$822.00 |
| | QMSF.FSE763026 | 30 | 26 | 76 | 105.0 | \$837.00 |
| | QMSF.FSE763030 | 30 | 30 | 76 | 114.7 | \$860.00 |
| | QMSF.FSE763032 | 30 | 32 | 76 | 119.5 | \$871.00 |
| 36" WIDE | QMSF.FSE763624 | 36 | 24 | 76 | 103.6 | \$828.00 |
| | QMSF.FSE763626 | 36 | 26 | 76 | 108.4 | \$846.00 |
| | QMSF.FSE763630 | 36 | 30 | 76 | 118.4 | \$868.00 |
| | QMSF.FSE763632 | 36 | 32 | 76 | 123.3 | \$879.00 |
| 39 3/8" WIDE | QMSF.FSE763924 | 39 | 24 | 76 | 105.5 | \$832.00 |
| | QMSF.FSE763926 | 39 | 26 | 76 | 110.3 | \$849.00 |
| | QMSF.FSE763930 | 39 | 30 | 76 | 120.4 | \$871.00 |
| | QMSF.FSE763932 | 39 | 32 | 76 | 125.4 | \$884.00 |
| 42" WIDE | QMSF.FSE764224 | 42 | 24 | 76 | 106.9 | \$836.00 |
| | QMSF.FSE764226 | 42 | 26 | 76 | 111.9 | \$854.00 |
| | QMSF.FSE764230 | 42 | 30 | 76 | 122.0 | \$876.00 |
| | QMSF.FSE764232 | 42 | 32 | 76 | 127.0 | \$888.00 |
| 48" WIDE | QMSF.FSE764824 | 48 | 24 | 76 | 110.3 | \$845.00 |
| | QMSF.FSE764826 | 48 | 26 | 76 | 115.3 | \$862.00 |
| | QMSF.FSE764830 | 48 | 30 | 76 | 125.6 | \$886.00 |
| | QMSF.FSE764832 | 48 | 32 | 76 | 130.8 | \$897.00 |

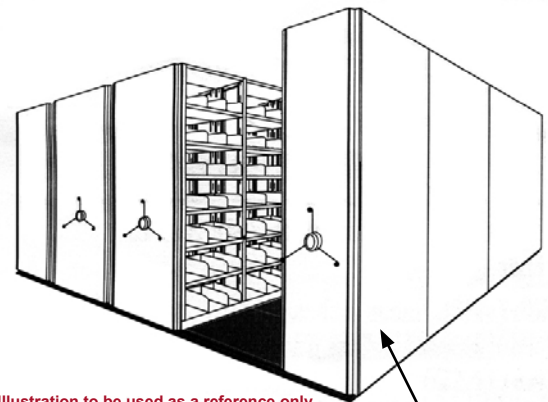

Illustration to be used as a reference only

Shelves and modular floor not included (see page **QM/42-QM/49** for shelves and see page **QM/27** for floor)

- Components for a double face full depth **starter**
- 1 double carriage with bumper
 - 1 front panel
 - 2 upright frames
 - 1 canopy top

Notes :

- Aluminium extrusions not available
- Add 5" high for the overall height
- Maximum length = 12 feet



Issued 06-01-2005

QM/9

QUADRAMOBILE SMARTSHELF FULL DEPTH

Fixed section 85" high

QUADRAMOBILE

| CODE # | W | D | H | lbs | \$ | |
|--|----------------|----|----|-----|-------|-----------------|
| | Frame | | | | | |
| STARTER DOUBLE FACE FULL DEPTH SHELVING - FIXED | | | | | | |
| 30" WIDE | QMSF.FSE853024 | 30 | 24 | 85 | 106.2 | \$835.00 |
| | QMSF.FSE853026 | 30 | 26 | 85 | 111.1 | \$850.00 |
| | QMSF.FSE853030 | 30 | 30 | 85 | 121.2 | \$874.00 |
| | QMSF.FSE853032 | 30 | 32 | 85 | 126.2 | \$886.00 |
| 36" WIDE | QMSF.FSE853624 | 36 | 24 | 85 | 109.5 | \$842.00 |
| | QMSF.FSE853626 | 36 | 26 | 85 | 114.5 | \$859.00 |
| | QMSF.FSE853630 | 36 | 30 | 85 | 124.8 | \$882.00 |
| | QMSF.FSE853632 | 36 | 32 | 85 | 129.9 | \$894.00 |
| 39 3/8" WIDE | QMSF.FSE853924 | 39 | 24 | 85 | 111.4 | \$845.00 |
| | QMSF.FSE853926 | 39 | 26 | 85 | 116.3 | \$863.00 |
| | QMSF.FSE853930 | 39 | 30 | 85 | 126.8 | \$886.00 |
| | QMSF.FSE853932 | 39 | 32 | 85 | 132.0 | \$899.00 |
| 42" WIDE | QMSF.FSE854224 | 42 | 24 | 85 | 112.8 | \$850.00 |
| | QMSF.FSE854226 | 42 | 26 | 85 | 117.9 | \$867.00 |
| | QMSF.FSE854230 | 42 | 30 | 85 | 128.4 | \$891.00 |
| | QMSF.FSE854232 | 42 | 32 | 85 | 133.7 | \$903.00 |
| 48" WIDE | QMSF.FSE854824 | 48 | 24 | 85 | 116.1 | \$858.00 |
| | QMSF.FSE854826 | 48 | 26 | 85 | 121.4 | \$875.00 |
| | QMSF.FSE854830 | 48 | 30 | 85 | 132.1 | \$900.00 |
| | QMSF.FSE854832 | 48 | 32 | 85 | 137.4 | \$912.00 |

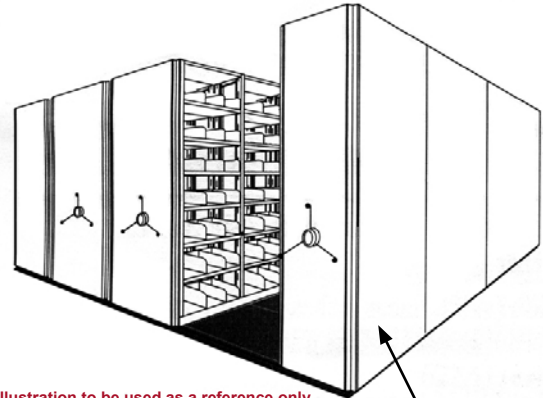

Illustration to be used as a reference only

Shelves and modular floor not included (see page **QM/42-QM/49** for shelves and see page **QM/27** for floor)

STARTER

Components for a double face full depth **starter**

- 1 double carriage with bumper
- 1 front panel
- 2 upright frames
- 1 canopy top

Notes :

- Aluminium extrusions not available
- Add 5" high for the overall height
- Maximum length = 12 feet

QM/10

Issued 06-01-2005

MONTEL AETNASTAK

GSA

Schedule

Contract GS-28F-8817M

QUADRAMOBILE SMARTSHELF FULL DEPTH

Fixed section 88" high

QUADRAMOBILE

| | CODE # | W | D | H | lbs | \$ |
|--|----------------|-------|----|----|-------|-----------------|
| | | Frame | | | | |
| STARTER DOUBLE FACE FULL DEPTH SHELVING - FIXED | | | | | | |
| 30" WIDE | QMSF.FSE883024 | 30 | 24 | 88 | 108.1 | \$838.00 |
| | QMSF.FSE883026 | 30 | 26 | 88 | 118.6 | \$875.00 |
| | QMSF.FSE883030 | 30 | 30 | 88 | 129.7 | \$901.00 |
| | QMSF.FSE883032 | 30 | 32 | 88 | 135.2 | \$914.00 |
| 36" WIDE | QMSF.FSE883624 | 36 | 24 | 88 | 111.4 | \$844.00 |
| | QMSF.FSE883626 | 36 | 26 | 88 | 122.0 | \$884.00 |
| | QMSF.FSE883630 | 36 | 30 | 88 | 133.3 | \$910.00 |
| | QMSF.FSE883632 | 36 | 32 | 88 | 139.0 | \$923.00 |
| 39 3/8" WIDE | QMSF.FSE883924 | 39 | 24 | 88 | 113.3 | \$848.00 |
| | QMSF.FSE883926 | 39 | 26 | 88 | 123.8 | \$888.00 |
| | QMSF.FSE883930 | 39 | 30 | 88 | 135.4 | \$913.00 |
| | QMSF.FSE883932 | 39 | 32 | 88 | 141.1 | \$928.00 |
| 42" WIDE | QMSF.FSE884224 | 42 | 24 | 88 | 114.8 | \$852.00 |
| | QMSF.FSE884226 | 42 | 26 | 88 | 125.4 | \$892.00 |
| | QMSF.FSE884230 | 42 | 30 | 88 | 137.0 | \$918.00 |
| | QMSF.FSE884232 | 42 | 32 | 88 | 142.7 | \$932.00 |
| 48" WIDE | QMSF.FSE884824 | 48 | 24 | 88 | 118.1 | \$861.00 |
| | QMSF.FSE884826 | 48 | 26 | 88 | 128.8 | \$900.00 |
| | QMSF.FSE884830 | 48 | 30 | 88 | 140.6 | \$928.00 |
| | QMSF.FSE884832 | 48 | 32 | 88 | 146.4 | \$940.00 |

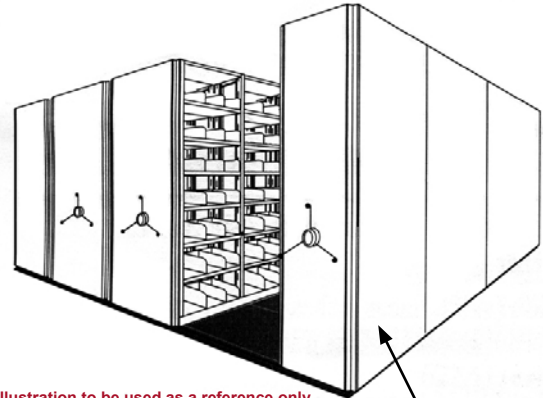

Illustration to be used as a reference only

Shelves and modular floor not included (see page **QM/42-QM/49** for shelves and see page **QM/27** for floor)

STARTER

Components for a double face full depth **starter**

- 1 double carriage with bumper
- 1 front panel
- 2 upright frames
- 1 canopy top

Notes :

- Aluminium extrusions not available
- Add 5" high for the overall height
- Maximum length = 12 feet

QUADRAMOBILE SMARTSHELF FULL DEPTH

Fixed section 76" high

QUADRAMOBILE

| CODE # | W | D | H | lbs | \$ | |
|--|----------------|----|----|-----|------|----------|
| | Frame | | | | | |
| ADDER DOUBLE FACE FULL DEPTH SHELVING - FIXED | | | | | | |
| 30" WIDE | QMSF.FAE763024 | 30 | 24 | 76 | 48.8 | \$405.00 |
| | QMSF.FAE763026 | 30 | 26 | 76 | 50.8 | \$410.00 |
| | QMSF.FAE763030 | 30 | 30 | 76 | 55.1 | \$420.00 |
| | QMSF.FAE763032 | 30 | 32 | 76 | 57.2 | \$425.00 |
| 36" WIDE | QMSF.FAE763624 | 36 | 24 | 76 | 52.1 | \$412.00 |
| | QMSF.FAE763626 | 36 | 26 | 76 | 54.3 | \$419.00 |
| | QMSF.FAE763630 | 36 | 30 | 76 | 58.7 | \$429.00 |
| | QMSF.FAE763632 | 36 | 32 | 76 | 60.9 | \$433.00 |
| 39 3/8" WIDE | QMSF.FAE763924 | 39 | 24 | 76 | 54.0 | \$416.00 |
| | QMSF.FAE763926 | 39 | 26 | 76 | 56.1 | \$423.00 |
| | QMSF.FAE763930 | 39 | 30 | 76 | 60.8 | \$432.00 |
| | QMSF.FAE763932 | 39 | 32 | 76 | 63.0 | \$438.00 |
| 42" WIDE | QMSF.FAE764224 | 42 | 24 | 76 | 55.4 | \$419.00 |
| | QMSF.FAE764226 | 42 | 26 | 76 | 57.7 | \$426.00 |
| | QMSF.FAE764230 | 42 | 30 | 76 | 62.4 | \$437.00 |
| | QMSF.FAE764232 | 42 | 32 | 76 | 64.7 | \$442.00 |
| 48" WIDE | QMSF.FAE764824 | 48 | 24 | 76 | 58.8 | \$429.00 |
| | QMSF.FAE764826 | 48 | 26 | 76 | 61.1 | \$435.00 |
| | QMSF.FAE764830 | 48 | 30 | 76 | 66.0 | \$446.00 |
| | QMSF.FAE764832 | 48 | 32 | 76 | 68.4 | \$451.00 |

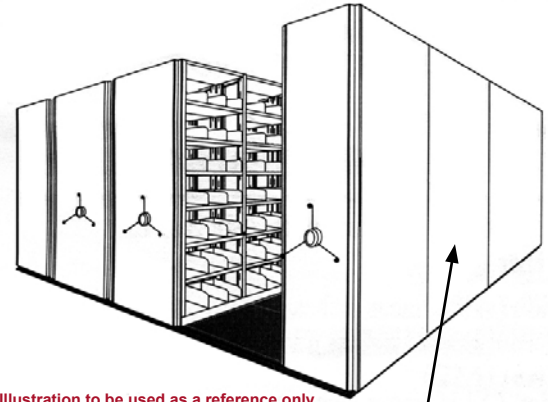

Illustration to be used as a reference only

Shelves and modular floor not included (see page **QM/42-QM/49** for shelves and see page **QM/27** for floor) **ADDER**

Components for a double face full depth **adder**

- 1 double carriage
- 1 upright frame
- 1 canopy top

Notes :

- Aluminium extrusions not available
- Add 5" high for the overall height
- Maximum length = 12 feet

QM/12

Issued 06-01-2005



QUADRAMOBILE SMARTSHELF FULL DEPTH

Fixed section 85" high

QUADRAMOBILE

| | CODE # | W | D | H | lbs | \$ |
|--|----------------|-------|----|----|------|----------|
| | | Frame | | | | |
| ADDER DOUBLE FACE FULL DEPTH SHELVING - FIXED | | | | | | |
| 30" WIDE | QMSF.FAE853024 | 30 | 24 | 85 | 50.4 | \$408.00 |
| | QMSF.FAE853026 | 30 | 26 | 85 | 52.4 | \$414.00 |
| | QMSF.FAE853030 | 30 | 30 | 85 | 56.7 | \$423.00 |
| | QMSF.FAE853032 | 30 | 32 | 85 | 58.8 | \$428.00 |
| 36" WIDE | QMSF.FAE853624 | 36 | 24 | 85 | 53.7 | \$416.00 |
| | QMSF.FAE853626 | 36 | 26 | 85 | 55.8 | \$422.00 |
| | QMSF.FAE853630 | 36 | 30 | 85 | 60.3 | \$433.00 |
| | QMSF.FAE853632 | 36 | 32 | 85 | 62.5 | \$437.00 |
| 39 3/8" WIDE | QMSF.FAE853924 | 39 | 24 | 85 | 55.6 | \$419.00 |
| | QMSF.FAE853926 | 39 | 26 | 85 | 57.7 | \$426.00 |
| | QMSF.FAE853930 | 39 | 30 | 85 | 62.4 | \$435.00 |
| | QMSF.FAE853932 | 39 | 32 | 85 | 64.6 | \$442.00 |
| 42" WIDE | QMSF.FAE854224 | 42 | 24 | 85 | 57.0 | \$422.00 |
| | QMSF.FAE854226 | 42 | 26 | 85 | 59.3 | \$430.00 |
| | QMSF.FAE854230 | 42 | 30 | 85 | 64.0 | \$440.00 |
| | QMSF.FAE854232 | 42 | 32 | 85 | 66.3 | \$446.00 |
| 48" WIDE | QMSF.FAE854824 | 48 | 24 | 85 | 60.3 | \$432.00 |
| | QMSF.FAE854826 | 48 | 26 | 85 | 62.7 | \$439.00 |
| | QMSF.FAE854830 | 48 | 30 | 85 | 67.6 | \$450.00 |
| | QMSF.FAE854832 | 48 | 32 | 85 | 70.0 | \$454.00 |

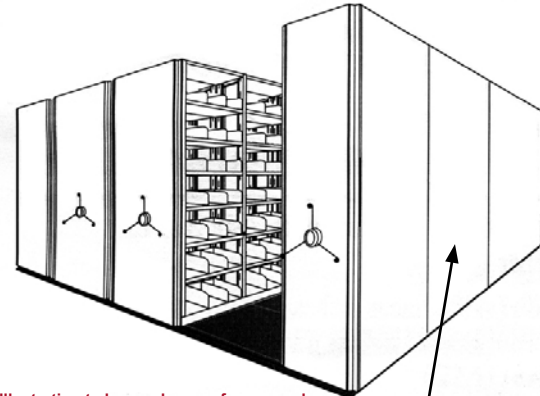

Illustration to be used as a reference only

Shelves and modular floor not included (see page **QM/42-QM/49** for shelves and see page **QM/27** for floor) **ADDER**

Components for a double face full depth **adder**

- 1 double carriage
- 1 upright frame
- 1 canopy top

Notes :

- Aluminium extrusions not available
- Add 5" high for the overall height
- Maximum length = 12 feet

QUADRAMOBILE SMARTSHELF FULL DEPTH

Fixed section 88" high

QUADRAMOBILE

| | CODE # | W | D | H | lbs | \$ |
|--|----------------|-------|----|----|------|----------|
| | | Frame | | | | |
| ADDER DOUBLE FACE FULL DEPTH SHELVING - FIXED | | | | | | |
| 30" WIDE | QMSF.FAE883024 | 30 | 24 | 88 | 50.9 | \$409.00 |
| | QMSF.FAE883026 | 30 | 26 | 88 | 55.7 | \$425.00 |
| | QMSF.FAE883030 | 30 | 30 | 88 | 60.4 | \$436.00 |
| | QMSF.FAE883032 | 30 | 32 | 88 | 62.7 | \$441.00 |
| 36" WIDE | QMSF.FAE883624 | 36 | 24 | 88 | 54.2 | \$417.00 |
| | QMSF.FAE883626 | 36 | 26 | 88 | 59.1 | \$434.00 |
| | QMSF.FAE883630 | 36 | 30 | 88 | 64.0 | \$445.00 |
| | QMSF.FAE883632 | 36 | 32 | 88 | 66.5 | \$449.00 |
| 39 3/8" WIDE | QMSF.FAE883924 | 39 | 24 | 88 | 56.1 | \$421.00 |
| | QMSF.FAE883926 | 39 | 26 | 88 | 60.9 | \$437.00 |
| | QMSF.FAE883930 | 39 | 30 | 88 | 66.1 | \$448.00 |
| | QMSF.FAE883932 | 39 | 32 | 88 | 68.6 | \$455.00 |
| 42" WIDE | QMSF.FAE884224 | 42 | 24 | 88 | 57.5 | \$424.00 |
| | QMSF.FAE884226 | 42 | 26 | 88 | 62.5 | \$441.00 |
| | QMSF.FAE884230 | 42 | 30 | 88 | 67.7 | \$453.00 |
| | QMSF.FAE884232 | 42 | 32 | 88 | 70.2 | \$458.00 |
| 48" WIDE | QMSF.FAE884824 | 48 | 24 | 88 | 60.9 | \$433.00 |
| | QMSF.FAE884826 | 48 | 26 | 88 | 66.0 | \$450.00 |
| | QMSF.FAE884830 | 48 | 30 | 88 | 71.3 | \$462.00 |
| | QMSF.FAE884832 | 48 | 32 | 88 | 74.0 | \$467.00 |

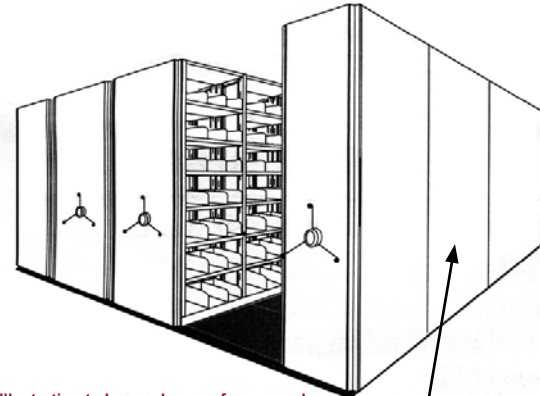

Illustration to be used as a reference only

Shelves and modular floor not included (see page **QM/42-QM/49** for shelves and see page **QM/27** for floor) **ADDER**

Components for a double face full depth **adder**

- 1 double carriage
- 1 upright frame
- 1 canopy top

Notes :

- Aluminium extrusions not available
- Add 5" high for the overall height
- Maximum length = 12 feet

QM/14

Issued 06-01-2005



QUADRAMOBILE SMARTSHELF FULL DEPTH

Mobile section 76" high

QUADRAMOBILE

| CODE # | W | D | H | lbs | \$ | |
|--|------------------|----|----|-----|------|------------|
| | Frame | | | | | |
| STARTER SECTION SINGLE FACE SHELVING - MOBILE | | | | | | |
| 30" WIDE | QMSF.MSE763012 | 30 | 12 | 76 | 76.1 | \$1,290.00 |
| | QMSF.MSE763013 | 30 | 13 | 76 | 80.6 | \$1,295.00 |
| | QMSF.MSE763015 | 30 | 15 | 76 | 84.2 | \$1,307.00 |
| | QMSF.MSE763016 | 30 | 16 | 76 | 87.0 | \$1,312.00 |
| 36" WIDE | QMSF.MSE763612** | 36 | 12 | 76 | 78.8 | \$1,302.00 |
| | QMSF.MSE763613 | 36 | 13 | 76 | 83.3 | \$1,307.00 |
| | QMSF.MSE763615** | 36 | 15 | 76 | 87.1 | \$1,320.00 |
| | QMSF.MSE763616 | 36 | 16 | 76 | 89.9 | \$1,326.00 |
| 39 3/8" WIDE | QMSF.MSE763912 | 39 | 12 | 76 | 80.3 | \$1,309.00 |
| | QMSF.MSE763913 | 39 | 13 | 76 | 84.9 | \$1,314.00 |
| | QMSF.MSE763915 | 39 | 15 | 76 | 88.7 | \$1,327.00 |
| | QMSF.MSE763916 | 39 | 16 | 76 | 91.5 | \$1,333.00 |
| 42" WIDE | QMSF.MSE764212** | 42 | 12 | 76 | 81.5 | \$1,317.00 |
| | QMSF.MSE764213 | 42 | 13 | 76 | 86.1 | \$1,322.00 |
| | QMSF.MSE764215** | 42 | 15 | 76 | 89.9 | \$1,334.00 |
| | QMSF.MSE764216 | 42 | 16 | 76 | 92.8 | \$1,341.00 |
| 48" WIDE | QMSF.MSE764812 | 48 | 12 | 76 | 84.2 | \$1,336.00 |
| | QMSF.MSE764813 | 48 | 13 | 76 | 88.8 | \$1,341.00 |
| | QMSF.MSE764815 | 48 | 15 | 76 | 92.8 | \$1,353.00 |
| | QMSF.MSE764816 | 48 | 16 | 76 | 95.7 | \$1,360.00 |

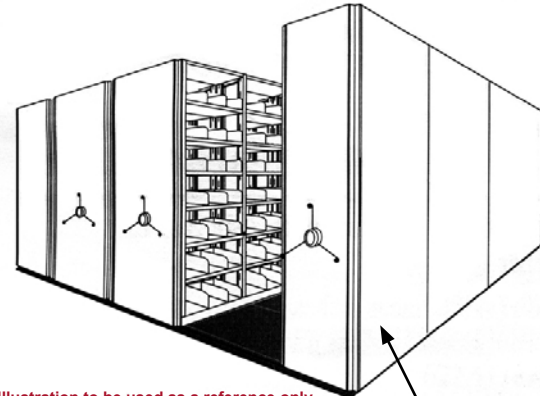

Illustration to be used as a reference only

Shelves and modular floor not included (see page [QM/42-QM/49](#) for shelves and see page [QM/27](#) for floor)

STARTER

Components for a single face **starter** section

- 1 single carriage with bumper
- 1 front panel+handle including a safety locking pin
- 2 upright frames
- 1 canopy top

Notes :

- Locking device not included (see page [QM/28](#))
- Aluminium extrusions not available
- Add 5" high for the overall height
- Maximum length = 12 feet
- ** Available on QuickShip program (see [QuickShip](#) tab)

QUADRAMOBILE SMARTSHELF FULL DEPTH

Mobile section 85" high

QUADRAMOBILE

| | CODE # | W | D | H | lbs | \$ |
|---------------------|------------------|-------|----|----|-------|------------|
| | | Frame | | | | |
| 30" WIDE | QMSF.MSE853012 | 30 | 12 | 85 | 80.9 | \$1,300.00 |
| | QMSF.MSE853013 | 30 | 13 | 85 | 85.4 | \$1,305.00 |
| | QMSF.MSE853015 | 30 | 15 | 85 | 89.2 | \$1,318.00 |
| | QMSF.MSE853016 | 30 | 16 | 85 | 92.1 | \$1,323.00 |
| 36" WIDE | QMSF.MSE853612** | 36 | 12 | 85 | 83.6 | \$1,313.00 |
| | QMSF.MSE853613 | 36 | 13 | 85 | 88.2 | \$1,318.00 |
| | QMSF.MSE853615** | 36 | 15 | 85 | 92.1 | \$1,331.00 |
| | QMSF.MSE853616 | 36 | 16 | 85 | 95.0 | \$1,337.00 |
| 39 3/8" WIDE | QMSF.MSE853912 | 39 | 12 | 85 | 85.1 | \$1,320.00 |
| | QMSF.MSE853913 | 39 | 13 | 85 | 89.7 | \$1,325.00 |
| | QMSF.MSE853915 | 39 | 15 | 85 | 93.7 | \$1,338.00 |
| | QMSF.MSE853916 | 39 | 16 | 85 | 96.6 | \$1,345.00 |
| 42" WIDE | QMSF.MSE854212** | 42 | 12 | 85 | 86.3 | \$1,326.00 |
| | QMSF.MSE854213 | 42 | 13 | 85 | 90.9 | \$1,333.00 |
| | QMSF.MSE854215** | 42 | 15 | 85 | 95.0 | \$1,346.00 |
| | QMSF.MSE854216 | 42 | 16 | 85 | 97.9 | \$1,352.00 |
| 48" WIDE | QMSF.MSE854812 | 48 | 12 | 85 | 89.0 | \$1,347.00 |
| | QMSF.MSE854813 | 48 | 13 | 85 | 93.7 | \$1,352.00 |
| | QMSF.MSE854815 | 48 | 15 | 85 | 97.8 | \$1,365.00 |
| | QMSF.MSE854816 | 48 | 16 | 85 | 100.8 | \$1,371.00 |

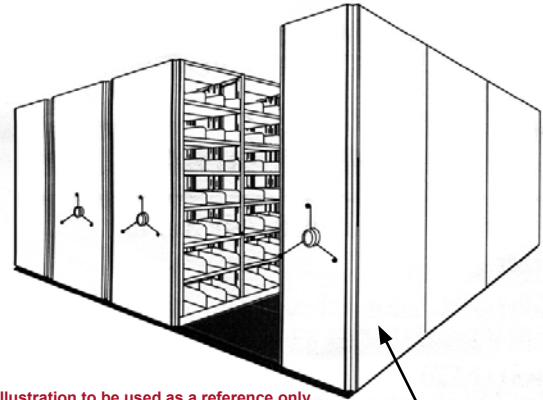

Illustration to be used as a reference only

Shelves and modular floor not included (see page **QM/42-QM/49** for shelves and see page **QM/27** for floor)

STARTER

Components for a single face **starter** section

- 1 single carriage with bumper
- 1 front panel+handle including a safety locking pin
- 2 upright frames
- 1 canopy top

Notes :

- Locking device not included (see page **QM/28**)
- Aluminium extrusions not available
- Add 5" high for the overall height
- Maximum length = 12 feet
- ** Available on QuickShip program (see **QuickShip** tab)

QM/16

Issued 06-01-2005



QUADRAMOBILE SMARTSHELF FULL DEPTH

Mobile section 88" high

QUADRAMOBILE

| CODE # | W | D | H | lbs | \$ | |
|--|------------------|----|----|-----|-------|------------|
| | Frame | | | | | |
| STARTER SECTION SINGLE FACE SHELVING - MOBILE | | | | | | |
| 30" WIDE | QMSF.MSE883012 | 30 | 12 | 88 | 82.5 | \$1,304.00 |
| | QMSF.MSE883013 | 30 | 13 | 88 | 87.0 | \$1,309.00 |
| | QMSF.MSE883015 | 30 | 15 | 88 | 90.9 | \$1,322.00 |
| | QMSF.MSE883016 | 30 | 16 | 88 | 93.8 | \$1,327.00 |
| 36" WIDE | QMSF.MSE883612** | 36 | 12 | 88 | 85.2 | \$1,317.00 |
| | QMSF.MSE883613 | 36 | 13 | 88 | 89.8 | \$1,322.00 |
| | QMSF.MSE883615** | 36 | 15 | 88 | 93.8 | \$1,335.00 |
| | QMSF.MSE883616 | 36 | 16 | 88 | 96.7 | \$1,341.00 |
| 39 3/8" WIDE | QMSF.MSE883912 | 39 | 12 | 88 | 86.7 | \$1,324.00 |
| | QMSF.MSE883913 | 39 | 13 | 88 | 91.3 | \$1,329.00 |
| | QMSF.MSE883915 | 39 | 15 | 88 | 95.4 | \$1,342.00 |
| | QMSF.MSE883916 | 39 | 16 | 88 | 98.4 | \$1,349.00 |
| 42" WIDE | QMSF.MSE884212** | 42 | 12 | 88 | 87.9 | \$1,330.00 |
| | QMSF.MSE884213 | 42 | 13 | 88 | 92.6 | \$1,336.00 |
| | QMSF.MSE884215** | 42 | 15 | 88 | 96.6 | \$1,349.00 |
| | QMSF.MSE884216 | 42 | 16 | 88 | 99.6 | \$1,356.00 |
| 48" WIDE | QMSF.MSE884812 | 48 | 12 | 88 | 90.6 | \$1,350.00 |
| | QMSF.MSE884813 | 48 | 13 | 88 | 95.3 | \$1,356.00 |
| | QMSF.MSE884815 | 48 | 15 | 88 | 99.5 | \$1,368.00 |
| | QMSF.MSE884816 | 48 | 16 | 88 | 102.5 | \$1,375.00 |

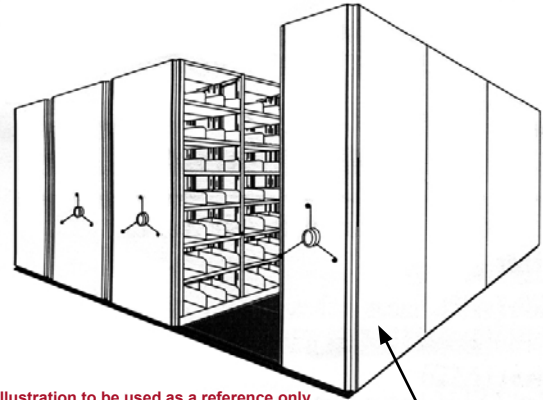

Illustration to be used as a reference only

Shelves and modular floor not included (see page [QM/42-QM/49](#) for shelves and see page [QM/27](#) for floor)

STARTER

Components for a single face **starter** section

- 1 single carriage with bumper
- 1 front panel+handle including a safety locking pin
- 2 upright frames
- 1 canopy top

Notes :

- Locking device not included (see page [QM/28](#))
- Aluminium extrusions not available
- Add 5" high for the overall height
- Maximum length = 12 feet
- ** Available on QuickShip program (see [QuickShip](#) tab)

QUADRAMOBILE SMARTSHELF FULL DEPTH

Mobile section 76" high

QUADRAMOBILE

| | CODE # | W | D | H | lbs | \$ |
|--|------------------|-------|----|----|------|----------|
| | | Frame | | | | |
| ADDER SECTION SINGLE FACE SHELVING - MOBILE | | | | | | |
| 30" WIDE | QMSF.MAE763012 | 30 | 12 | 76 | 36.7 | \$497.00 |
| | QMSF.MAE763013 | 30 | 13 | 76 | 37.8 | \$500.00 |
| | QMSF.MAE763015 | 30 | 15 | 76 | 40.1 | \$504.00 |
| | QMSF.MAE763016 | 30 | 16 | 76 | 41.2 | \$508.00 |
| 36" WIDE | QMSF.MAE763612** | 36 | 12 | 76 | 38.4 | \$508.00 |
| | QMSF.MAE763613 | 36 | 13 | 76 | 40.6 | \$512.00 |
| | QMSF.MAE763615** | 36 | 15 | 76 | 41.9 | \$517.00 |
| | QMSF.MAE763616 | 36 | 16 | 76 | 44.1 | \$519.00 |
| 39 3/8" WIDE | QMSF.MAE763912 | 39 | 12 | 76 | 40.9 | \$516.00 |
| | QMSF.MAE763913 | 39 | 13 | 76 | 42.1 | \$519.00 |
| | QMSF.MAE763915 | 39 | 15 | 76 | 44.6 | \$523.00 |
| | QMSF.MAE763916 | 39 | 16 | 76 | 45.7 | \$525.00 |
| 42" WIDE | QMSF.MAE764212** | 42 | 12 | 76 | 41.1 | \$524.00 |
| | QMSF.MAE764213 | 42 | 13 | 76 | 43.3 | \$526.00 |
| | QMSF.MAE764215** | 42 | 15 | 76 | 44.8 | \$532.00 |
| | QMSF.MAE764216 | 42 | 16 | 76 | 47.0 | \$534.00 |
| 48" WIDE | QMSF.MAE764812 | 48 | 12 | 76 | 44.8 | \$536.00 |
| | QMSF.MAE764813 | 48 | 13 | 76 | 46.1 | \$540.00 |
| | QMSF.MAE764815 | 48 | 15 | 76 | 48.7 | \$546.00 |
| | QMSF.MAE764816 | 48 | 16 | 76 | 49.9 | \$549.00 |

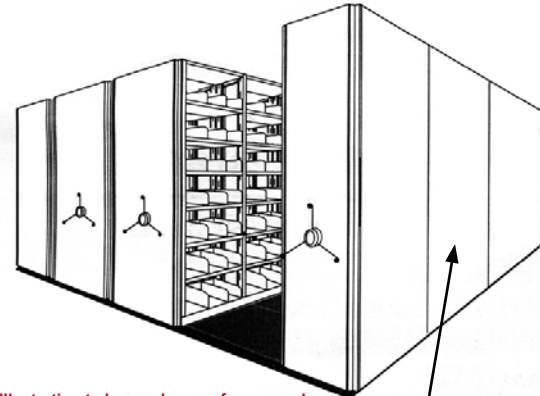

Illustration to be used as a reference only

Shelves and modular floor not included (see page **QM/42-QM/49** for shelves and see page **QM/27** for floor) **ADDER**

- Components for a single face **adder** section
- 1 single carriage
 - 1 upright frame
 - 1 canopy top

Notes :

- Aluminium extrusions not available
- Add 5" high for the overall height
- Maximum length = 12 feet
- ** Available on QuickShip program (see **QuickShip** tab)

QM/18

Issued 06-01-2005

QUADRAMOBILE SMARTSHELF FULL DEPTH

Mobile section 85" high

QUADRAMOBILE

| | CODE # | W | D | H | lbs | \$ |
|--|------------------|-------|----|----|------|-----------------|
| | | Frame | | | | |
| ADDER SECTION SINGLE FACE SHELVING - MOBILE | | | | | | |
| 30" WIDE | QMSF.MAE853012 | 30 | 12 | 85 | 38.3 | \$501.00 |
| | QMSF.MAE853013 | 30 | 13 | 85 | 39.4 | \$503.00 |
| | QMSF.MAE853015 | 30 | 15 | 85 | 41.7 | \$507.00 |
| | QMSF.MAE853016 | 30 | 16 | 85 | 42.8 | \$511.00 |
| 36" WIDE | QMSF.MAE853612** | 36 | 12 | 85 | 41.0 | \$512.00 |
| | QMSF.MAE853613 | 36 | 13 | 85 | 42.2 | \$515.00 |
| | QMSF.MAE853615** | 36 | 15 | 85 | 44.5 | \$520.00 |
| | QMSF.MAE853616 | 36 | 16 | 85 | 45.7 | \$523.00 |
| 39 3/8" WIDE | QMSF.MAE853912 | 39 | 12 | 85 | 42.5 | \$520.00 |
| | QMSF.MAE853913 | 39 | 13 | 85 | 43.7 | \$522.00 |
| | QMSF.MAE853915 | 39 | 15 | 85 | 46.1 | \$526.00 |
| | QMSF.MAE853916 | 39 | 16 | 85 | 47.3 | \$529.00 |
| 42" WIDE | QMSF.MAE854212** | 42 | 12 | 85 | 43.7 | \$527.00 |
| | QMSF.MAE854213 | 42 | 13 | 85 | 44.9 | \$530.00 |
| | QMSF.MAE854215** | 42 | 15 | 85 | 47.4 | \$535.00 |
| | QMSF.MAE854216 | 42 | 16 | 85 | 48.6 | \$537.00 |
| 48" WIDE | QMSF.MAE854812 | 48 | 12 | 85 | 46.4 | \$539.00 |
| | QMSF.MAE854813 | 48 | 13 | 85 | 47.7 | \$543.00 |
| | QMSF.MAE854815 | 48 | 15 | 85 | 50.2 | \$549.00 |
| | QMSF.MAE854816 | 48 | 16 | 85 | 51.5 | \$552.00 |

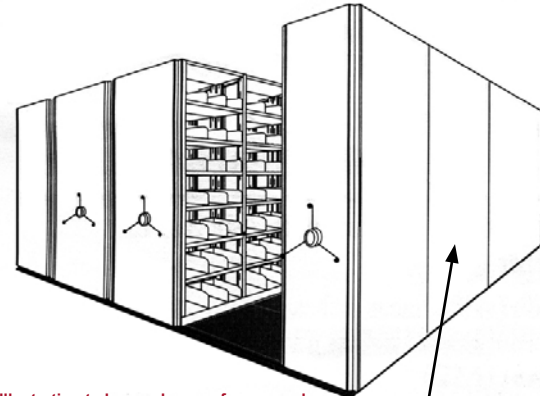

Illustration to be used as a reference only

Shelves and modular floor not included (see page **QM/42-QM/49** for shelves and see page **QM/27** for floor) **ADDER**

Components for a single face **adder** section

- 1 single carriage
- 1 upright frame
- 1 canopy top

Notes :

- Aluminium extrusions not available
- Add 5" high for the overall height
- Maximum length = 12 feet
- ** Available on QuickShip program (see **QuickShip** tab)

QUADRAMOBILE SMARTSHELF FULL DEPTH

Mobile section 88" high

QUADRAMOBILE

| CODE # | W | D | H | lbs | \$ | |
|--|------------------|----|----|-----|------|----------|
| | Frame | | | | | |
| ADDER SECTION SINGLE FACE SHELVING - MOBILE | | | | | | |
| 30" WIDE | QMSF.MAE883012 | 30 | 12 | 88 | 38.8 | \$502.00 |
| | QMSF.MAE883013 | 30 | 13 | 88 | 39.9 | \$504.00 |
| | QMSF.MAE883015 | 30 | 15 | 88 | 42.2 | \$508.00 |
| | QMSF.MAE883016 | 30 | 16 | 88 | 43.3 | \$512.00 |
| 36" WIDE | QMSF.MAE883612** | 36 | 12 | 88 | 40.3 | \$513.00 |
| | QMSF.MAE883613 | 36 | 13 | 88 | 42.7 | \$516.00 |
| | QMSF.MAE883615** | 36 | 15 | 88 | 43.9 | \$521.00 |
| | QMSF.MAE883616 | 36 | 16 | 88 | 46.2 | \$524.00 |
| 39 3/8" WIDE | QMSF.MAE883912 | 39 | 12 | 88 | 43.0 | \$521.00 |
| | QMSF.MAE883913 | 39 | 13 | 88 | 44.2 | \$523.00 |
| | QMSF.MAE883915 | 39 | 15 | 88 | 46.7 | \$527.00 |
| | QMSF.MAE883916 | 39 | 16 | 88 | 47.8 | \$530.00 |
| 42" WIDE | QMSF.MAE884212** | 42 | 12 | 88 | 43.0 | \$528.00 |
| | QMSF.MAE884213 | 42 | 13 | 88 | 45.5 | \$531.00 |
| | QMSF.MAE884215** | 42 | 15 | 88 | 46.7 | \$536.00 |
| | QMSF.MAE884216 | 42 | 16 | 88 | 49.1 | \$539.00 |
| 48" WIDE | QMSF.MAE884812 | 48 | 12 | 88 | 46.9 | \$540.00 |
| | QMSF.MAE884813 | 48 | 13 | 88 | 48.2 | \$544.00 |
| | QMSF.MAE884815 | 48 | 15 | 88 | 50.8 | \$551.00 |
| | QMSF.MAE884816 | 48 | 16 | 88 | 52.0 | \$553.00 |

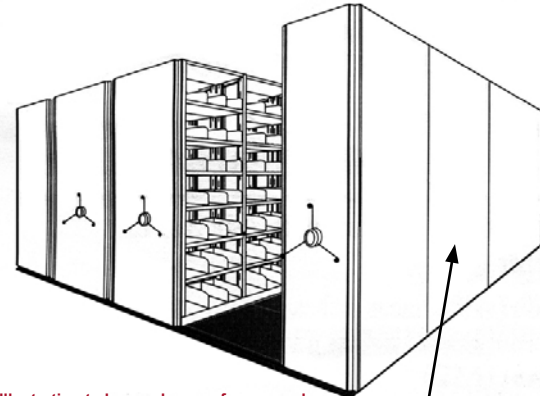

Illustration to be used as a reference only

Shelves and modular floor not included (see page **QM/42-QM/49** for shelves and see page **QM/27** for floor) **ADDER**

Components for a single face **adder** section

- 1 single carriage
- 1 upright frame
- 1 canopy top

Notes :

- Aluminium extrusions not available
- Add 5" high for the overall height
- Maximum length = 12 feet
- ** Available on QuickShip program (see **QuickShip** tab)

QM/20

Issued 06-01-2005



QUADRAMOBILE SMARTSHELF FULL DEPTH

Mobile section 76" high

QUADRAMOBILE

| | CODE # | W | D | H | lbs | \$ |
|---|-------------------|-------|----|----|-------|------------|
| | | Frame | | | | |
| STARTER DOUBLE FACE FULL DEPTH SHELVING - MOBILE | | | | | | |
| 30" WIDE | QMSF.MSED763024 | 30 | 12 | 76 | 105.1 | \$1,375.00 |
| | QMSF.MSED763026 | 30 | 13 | 76 | 110.3 | \$1,388.00 |
| | QMSF.MSED763030 | 30 | 15 | 76 | 120.5 | \$1,411.00 |
| | QMSF.MSED763032 | 30 | 16 | 76 | 125.8 | \$1,421.00 |
| 36" WIDE | QMSF.MSED763624** | 36 | 12 | 76 | 108.5 | \$1,389.00 |
| | QMSF.MSED763626 | 36 | 13 | 76 | 113.8 | \$1,404.00 |
| | QMSF.MSED763630** | 36 | 15 | 76 | 124.1 | \$1,425.00 |
| | QMSF.MSED763632 | 36 | 16 | 76 | 129.5 | \$1,437.00 |
| 39 3/8" WIDE | QMSF.MSED763924 | 39 | 12 | 76 | 110.3 | \$1,397.00 |
| | QMSF.MSED763926 | 39 | 13 | 76 | 115.6 | \$1,415.00 |
| | QMSF.MSED763930 | 39 | 15 | 76 | 126.2 | \$1,432.00 |
| | QMSF.MSED763932 | 39 | 16 | 76 | 131.7 | \$1,445.00 |
| 42" WIDE | QMSF.MSED764224** | 42 | 12 | 76 | 111.8 | \$1,405.00 |
| | QMSF.MSED764226 | 42 | 13 | 76 | 117.2 | \$1,420.00 |
| | QMSF.MSED764230** | 42 | 15 | 76 | 127.8 | \$1,442.00 |
| | QMSF.MSED764232 | 42 | 16 | 76 | 133.3 | \$1,454.00 |
| 48" WIDE | QMSF.MSED764824 | 48 | 12 | 76 | 115.1 | \$1,426.00 |
| | QMSF.MSED764826 | 48 | 13 | 76 | 120.6 | \$1,441.00 |
| | QMSF.MSED764830 | 48 | 15 | 76 | 131.4 | \$1,464.00 |
| | QMSF.MSED764832 | 48 | 16 | 76 | 137.0 | \$1,475.00 |

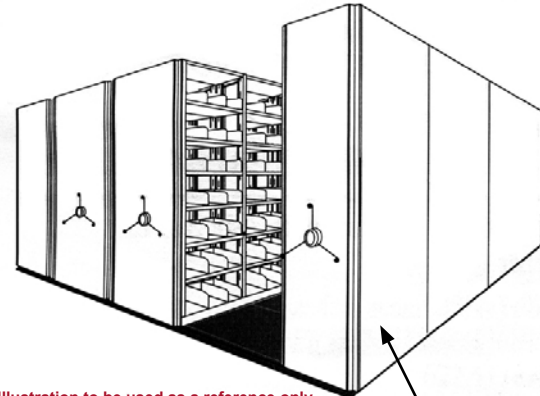

Illustration to be used as a reference only

Shelves and modular floor not included (see page **QM/42-QM/49** for shelves and see page **QM/27** for floor) **STARTER**

- Components for a double face full depth **starter**
- 1 double carriage with bumper
 - 1 front panel+handle including a safety locking pin
 - 2 upright frames
 - 1 canopy top

Notes :

- Aluminium extrusions not available
- Add 5" high for the overall height
- Maximum length = 12 feet
- ** Available on QuickShip program (see **QuickShip** tab)

QUADRAMOBILE SMARTSHELF FULL DEPTH

Mobile section 85" high

QUADRAMOBILE

| | CODE # | W | D | H | lbs | \$ |
|---------------------|---|-------|----|----|-------|------------|
| | | Frame | | | | |
| 30" WIDE | STARTER DOUBLE FACE FULL DEPTH SHELVING - MOBILE | | | | | |
| | QMSF.MSED853024 | 30 | 12 | 85 | 111.0 | \$1,388.00 |
| | QMSF.MSED853026 | 30 | 13 | 85 | 116.4 | \$1,401.00 |
| | QMSF.MSED853030 | 30 | 15 | 85 | 126.9 | \$1,425.00 |
| | QMSF.MSED853032 | 30 | 16 | 85 | 132.4 | \$1,436.00 |
| 36" WIDE | QMSF.MSED853624** | 36 | 12 | 85 | 114.3 | \$1,403.00 |
| | QMSF.MSED853626 | 36 | 13 | 85 | 119.8 | \$1,417.00 |
| | QMSF.MSED853630** | 36 | 15 | 85 | 130.6 | \$1,440.00 |
| | QMSF.MSED853632 | 36 | 16 | 85 | 136.2 | \$1,452.00 |
| 39 3/8" WIDE | QMSF.MSED853924 | 39 | 12 | 85 | 116.2 | \$1,410.00 |
| | QMSF.MSED853926 | 39 | 13 | 85 | 121.7 | \$1,429.00 |
| | QMSF.MSED853930 | 39 | 15 | 85 | 132.6 | \$1,447.00 |
| | QMSF.MSED853932 | 39 | 16 | 85 | 138.3 | \$1,460.00 |
| 42" WIDE | QMSF.MSED854224** | 42 | 12 | 85 | 117.7 | \$1,419.00 |
| | QMSF.MSED854226 | 42 | 13 | 85 | 123.3 | \$1,433.00 |
| | QMSF.MSED854230** | 42 | 15 | 85 | 134.2 | \$1,457.00 |
| | QMSF.MSED854232 | 42 | 16 | 85 | 139.9 | \$1,469.00 |
| 48" WIDE | QMSF.MSED854824 | 48 | 12 | 85 | 121.0 | \$1,439.00 |
| | QMSF.MSED854826 | 48 | 13 | 85 | 126.7 | \$1,454.00 |
| | QMSF.MSED854830 | 48 | 15 | 85 | 137.9 | \$1,478.00 |
| | QMSF.MSED854832 | 48 | 16 | 85 | 143.7 | \$1,490.00 |

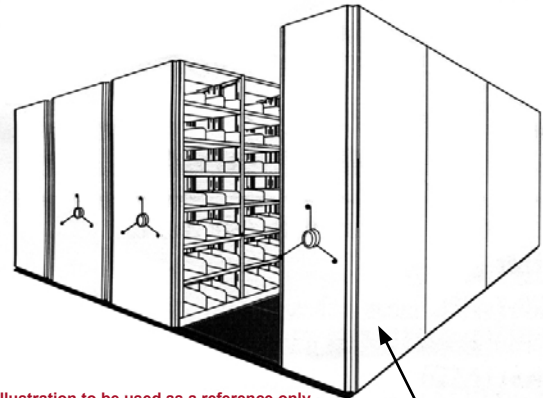

Illustration to be used as a reference only

Shelves and modular floor not included (see page **QM/42-QM/49** for shelves and see page **QM/27** for floor)

STARTER

Components for a double face full depth **starter**

- 1 double carriage with bumper
- 1 front panel+handle including a safety locking pin
- 2 upright frames
- 1 canopy top

Notes :

- Aluminium extrusions not available
- Add 5" high for the overall height
- Maximum length = 12 feet
- ** Available on QuickShip program (see **QuickShip** tab)

QM/22

Issued 06-01-2005

MONTEL AETNASTAK

GSA Schedule
Contract GS-28F-0017M

QUADRAMOBILE SMARTSHELF FULL DEPTH

Mobile section 88" high

QUADRAMOBILE

| | CODE # | W | D | H | lbs | \$ |
|---|-------------------|-------|----|----|-------|------------|
| | | Frame | | | | |
| STARTER DOUBLE FACE FULL DEPTH SHELVING - MOBILE | | | | | | |
| 30" WIDE | QMSF.MSED883024 | 30 | 12 | 88 | 113.0 | \$1,391.00 |
| | QMSF.MSED883026 | 30 | 13 | 88 | 123.9 | \$1,426.00 |
| | QMSF.MSED883030 | 30 | 15 | 88 | 135.5 | \$1,452.00 |
| | QMSF.MSED883032 | 30 | 16 | 88 | 141.5 | \$1,464.00 |
| 36" WIDE | QMSF.MSED883624** | 36 | 12 | 88 | 116.3 | \$1,405.00 |
| | QMSF.MSED883626 | 36 | 13 | 88 | 127.3 | \$1,442.00 |
| | QMSF.MSED883630** | 36 | 15 | 88 | 139.1 | \$1,467.00 |
| | QMSF.MSED883632 | 36 | 16 | 88 | 145.2 | \$1,481.00 |
| 39 3/8" WIDE | QMSF.MSED883924 | 39 | 12 | 88 | 118.2 | \$1,413.00 |
| | QMSF.MSED883926 | 39 | 13 | 88 | 129.2 | \$1,454.00 |
| | QMSF.MSED883930 | 39 | 15 | 88 | 141.2 | \$1,474.00 |
| | QMSF.MSED883932 | 39 | 16 | 88 | 147.3 | \$1,489.00 |
| 42" WIDE | QMSF.MSED884224** | 42 | 12 | 88 | 119.6 | \$1,421.00 |
| | QMSF.MSED884226 | 42 | 13 | 88 | 130.8 | \$1,458.00 |
| | QMSF.MSED884230** | 42 | 15 | 88 | 142.8 | \$1,484.00 |
| | QMSF.MSED884232 | 42 | 16 | 88 | 149.0 | \$1,498.00 |
| 48" WIDE | QMSF.MSED884824 | 48 | 12 | 88 | 123.0 | \$1,442.00 |
| | QMSF.MSED884826 | 48 | 13 | 88 | 134.2 | \$1,479.00 |
| | QMSF.MSED884830 | 48 | 15 | 88 | 146.4 | \$1,506.00 |
| | QMSF.MSED884832 | 48 | 16 | 88 | 152.7 | \$1,518.00 |

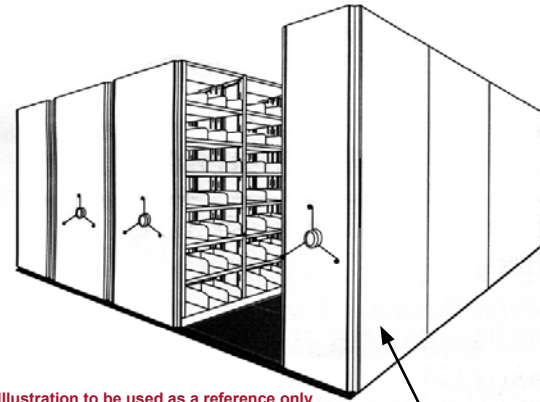

Illustration to be used as a reference only

Shelves and modular floor not included (see page **QM/42-QM/49** for shelves and see page **QM/27** for floor) **STARTER**

Components for a double face full depth **starter**

- 1 double carriage with bumper
- 1 front panel+handle including a safety locking pin
- 2 upright frames
- 1 canopy top

Notes :

- Aluminium extrusions not available
- Add 5" high for the overall height
- Maximum length = 12 feet
- ** Available on QuickShip program (see **QuickShip** tab)

QUADRAMOBILE SMARTSHELF FULL DEPTH

Mobile section 76" high

QUADRAMOBILE

| CODE # | W | D | H | lbs | \$ | |
|---|-------------------|----|----|-----|------|----------|
| | Frame | | | | | |
| ADDER DOUBLE FACE FULL DEPTH SHELVING - MOBILE | | | | | | |
| 30" WIDE | QMSF.MAED763024 | 30 | 12 | 76 | 48.8 | \$525.00 |
| | QMSF.MAED763026 | 30 | 13 | 76 | 50.8 | \$529.00 |
| | QMSF.MAED763030 | 30 | 15 | 76 | 55.1 | \$540.00 |
| | QMSF.MAED763032 | 30 | 16 | 76 | 57.2 | \$544.00 |
| 36" WIDE | QMSF.MAED763624** | 36 | 12 | 76 | 52.1 | \$536.00 |
| | QMSF.MAED763626 | 36 | 13 | 76 | 54.3 | \$543.00 |
| | QMSF.MAED763630** | 36 | 15 | 76 | 58.7 | \$553.00 |
| | QMSF.MAED763632 | 36 | 16 | 76 | 60.9 | \$558.00 |
| 39 3/8" WIDE | QMSF.MAED763924 | 39 | 12 | 76 | 54.0 | \$545.00 |
| | QMSF.MAED763926 | 39 | 13 | 76 | 56.1 | \$551.00 |
| | QMSF.MAED763930 | 39 | 15 | 76 | 60.8 | \$559.00 |
| | QMSF.MAED763932 | 39 | 16 | 76 | 63.1 | \$566.00 |
| 42" WIDE | QMSF.MAED764224** | 42 | 12 | 76 | 55.4 | \$553.00 |
| | QMSF.MAED764226 | 42 | 13 | 76 | 57.7 | \$559.00 |
| | QMSF.MAED764230** | 42 | 15 | 76 | 62.4 | \$569.00 |
| | QMSF.MAED764232 | 42 | 16 | 76 | 64.7 | \$574.00 |
| 48" WIDE | QMSF.MAED764824 | 48 | 12 | 76 | 58.8 | \$567.00 |
| | QMSF.MAED764826 | 48 | 13 | 76 | 61.1 | \$575.00 |
| | QMSF.MAED764830 | 48 | 15 | 76 | 66.0 | \$585.00 |
| | QMSF.MAED764832 | 48 | 16 | 76 | 68.4 | \$591.00 |

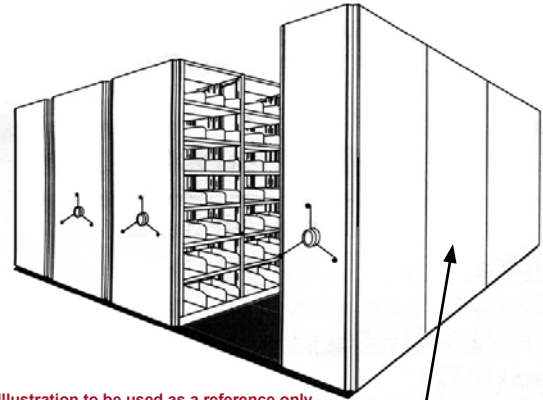

Illustration to be used as a reference only

Shelves and modular floor not included (see page **QM/42-QM/49** for shelves and see page **QM/27** for floor) **ADDER**

Components for a double face full depth **adder**

- 1 double carriage
- 1 upright frame
- 1 canopy top

Notes :

- Aluminium extrusions not available
- Add 5" high for the overall height
- Maximum length = 12 feet
- ** Available on QuickShip program (see **QuickShip** tab)

QM/24

Issued 06-01-2005

MONTEL AETNASTAK

GSA Schedule
Contract GS-28F-8817M

QUADRAMOBILE SMARTSHELF FULL DEPTH

Mobile section 85" high

QUADRAMOBILE

| CODE # | W | D | H | lbs | \$ | |
|---|-------------------|----|----|-----|------|----------|
| | Frame | | | | | |
| ADDER DOUBLE FACE FULL DEPTH SHELVING - MOBILE | | | | | | |
| 30" WIDE | QMSF.MAED853024 | 30 | 12 | 85 | 50.4 | \$528.00 |
| | QMSF.MAED853026 | 30 | 13 | 85 | 52.4 | \$533.00 |
| | QMSF.MAED853030 | 30 | 15 | 85 | 56.7 | \$543.00 |
| | QMSF.MAED853032 | 30 | 16 | 85 | 58.8 | \$547.00 |
| 36" WIDE | QMSF.MAED853624** | 36 | 12 | 85 | 53.7 | \$539.00 |
| | QMSF.MAED853626 | 36 | 13 | 85 | 55.8 | \$546.00 |
| | QMSF.MAED853630** | 36 | 15 | 85 | 60.3 | \$557.00 |
| | QMSF.MAED853632 | 36 | 16 | 85 | 62.5 | \$562.00 |
| 39 3/8" WIDE | QMSF.MAED853924 | 39 | 12 | 85 | 55.6 | \$548.00 |
| | QMSF.MAED853926 | 39 | 13 | 85 | 57.7 | \$554.00 |
| | QMSF.MAED853930 | 39 | 15 | 85 | 62.4 | \$562.00 |
| | QMSF.MAED853932 | 39 | 16 | 85 | 64.6 | \$570.00 |
| 42" WIDE | QMSF.MAED854224** | 42 | 12 | 85 | 57.0 | \$556.00 |
| | QMSF.MAED854226 | 42 | 13 | 85 | 59.3 | \$563.00 |
| | QMSF.MAED854230** | 42 | 15 | 85 | 64.0 | \$573.00 |
| | QMSF.MAED854232 | 42 | 16 | 85 | 66.3 | \$578.00 |
| 48" WIDE | QMSF.MAED854824 | 48 | 12 | 85 | 60.3 | \$570.00 |
| | QMSF.MAED854826 | 48 | 13 | 85 | 62.7 | \$579.00 |
| | QMSF.MAED854830 | 48 | 15 | 85 | 67.6 | \$589.00 |
| | QMSF.MAED854832 | 48 | 16 | 85 | 70.0 | \$594.00 |

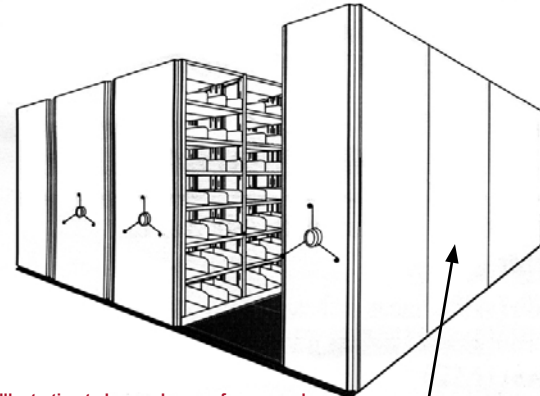

Illustration to be used as a reference only

Shelves and modular floor not included (see page **QM/42-QM/49** for shelves and see page **QM/27** for floor) **ADDER**

Components for a double face full depth **adder**

- 1 double carriage
- 1 upright frame
- 1 canopy top

Notes :

- Aluminium extrusions not available
- Add 5" high for the overall height
- Maximum length = 12 feet
- ** Available on QuickShip program (see **QuickShip** tab)



Issued 06-01-2005

QM/25

QUADRAMOBILE SMARTSHELF FULL DEPTH

Mobile section 88" high

QUADRAMOBILE

| | CODE # | W | D | H | lbs | \$ |
|---|-------------------|-------|----|----|------|----------|
| | | Frame | | | | |
| ADDER DOUBLE FACE FULL DEPTH SHELVING - MOBILE | | | | | | |
| 30" WIDE | QMSF.MAED883024 | 30 | 12 | 88 | 50.9 | \$529.00 |
| | QMSF.MAED883026 | 30 | 13 | 88 | 55.7 | \$544.00 |
| | QMSF.MAED883030 | 30 | 15 | 88 | 60.4 | \$556.00 |
| | QMSF.MAED883032 | 30 | 16 | 88 | 62.7 | \$560.00 |
| 36" WIDE | QMSF.MAED883624** | 36 | 12 | 88 | 54.2 | \$541.00 |
| | QMSF.MAED883626 | 36 | 13 | 88 | 59.1 | \$558.00 |
| | QMSF.MAED883630** | 36 | 15 | 88 | 64.0 | \$568.00 |
| | QMSF.MAED883632 | 36 | 16 | 88 | 66.5 | \$574.00 |
| 39 3/8" WIDE | QMSF.MAED883924 | 39 | 12 | 88 | 56.1 | \$550.00 |
| | QMSF.MAED883926 | 39 | 13 | 88 | 60.9 | \$565.00 |
| | QMSF.MAED883930 | 39 | 15 | 88 | 66.1 | \$575.00 |
| | QMSF.MAED883932 | 39 | 16 | 88 | 68.6 | \$583.00 |
| 42" WIDE | QMSF.MAED884224** | 42 | 12 | 88 | 57.5 | \$557.00 |
| | QMSF.MAED884226 | 42 | 13 | 88 | 62.5 | \$574.00 |
| | QMSF.MAED884230** | 42 | 15 | 88 | 67.7 | \$585.00 |
| | QMSF.MAED884232 | 42 | 16 | 88 | 70.2 | \$590.00 |
| 48" WIDE | QMSF.MAED884824 | 48 | 12 | 88 | 60.9 | \$571.00 |
| | QMSF.MAED884826 | 48 | 13 | 88 | 66.0 | \$590.00 |
| | QMSF.MAED884830 | 48 | 15 | 88 | 71.3 | \$601.00 |
| | QMSF.MAED884832 | 48 | 16 | 88 | 74.0 | \$607.00 |

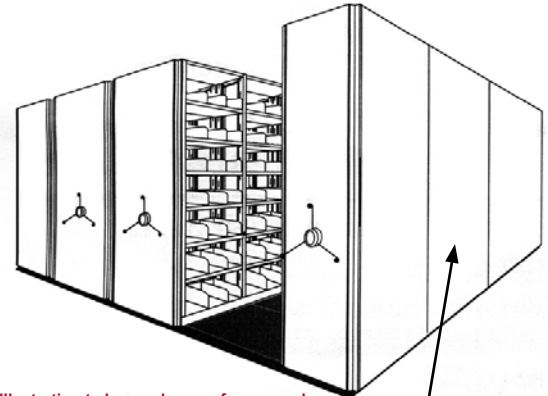

Illustration to be used as a reference only

Shelves and modular floor not included (see page **QM/42-QM/49** for shelves and see page **QM/27** for floor)

Components for a double face full depth **adder**

- 1 double carriage
- 1 upright frame
- 1 canopy top

Notes :

- Aluminium extrusions not available
- Add 5" high for the overall height
- Maximum length = 12 feet
- ** Available on QuickShip program (see **QuickShip** tab)

QM/26

Issued 06-01-2005



MODULAR FLOOR

Starter and adder

QUADRAMOBILE

| CODE # | W | D | H | lbs | \$ per inches |
|--------|---|---|---|-----|------------------|
|--------|---|---|---|-----|------------------|

MODULAR FLOOR FOR A STARTER SECTION

| | | | | | |
|--------------|--------|--------|---|-----|----------------|
| QMFLS.30/xxx | 30 | 34 | - | 0.7 | \$10.15 |
| QMFLS.36/xxx | 36 | 40 | - | 0.8 | \$10.15 |
| QMFLS.1M/xxx | 39 3/8 | 43 3/8 | - | 0.9 | \$10.25 |
| QMFLS.42/xxx | 42 | 46 | - | 1.0 | \$10.25 |
| QMFLS.48/xxx | 48 | 52 | - | 1.3 | \$11.10 |

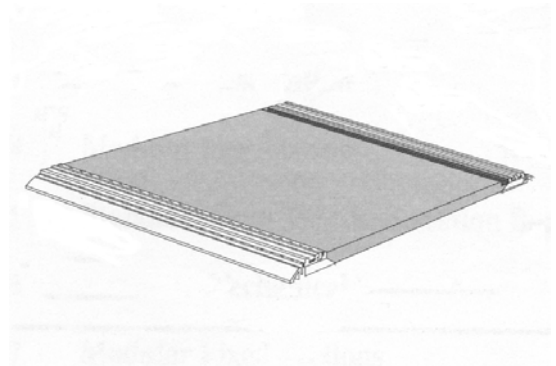

MODULAR FLOOR FOR A ADDER SECTION

| | | | | | |
|--------------|--------|--------|---|-----|---------------|
| QMFLA.30/xxx | 30 | 30 | - | 0.6 | \$7.75 |
| QMFLA.36/xxx | 36 | 36 | - | 0.7 | \$7.75 |
| QMFLA.1M/xxx | 39 3/8 | 39 3/8 | - | 0.8 | \$8.45 |
| QMFLA.42/xxx | 42 | 42 | - | 0.9 | \$8.45 |
| QMFLA.48/xxx | 48 | 48 | - | 1.2 | \$9.00 |

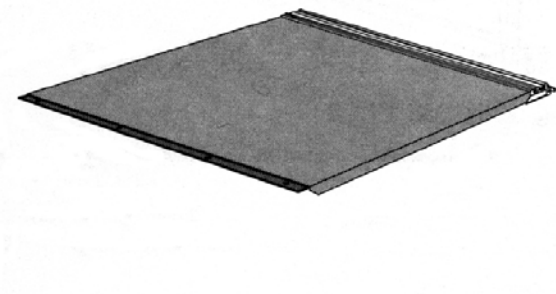

Notes :

- Ex. : You have 2 sections 36"W and you want 200" floor. You need : 1 QMFLS.36/200
1 QMFLA.36/200

CODE # W D H lbs \$

STEEL RAMP

RAMPQM/xxx Inches 4.0 \$2.70

STEEL RAMP FOR WHEEL CHAIR

RAMPQMADA/xxx Inches 7.0 \$5.28

STAINLESS STEEL RAMP

RAMPQMINOX/xxx Inches 4.0 \$5.28

STAINLESS STEEL RAMP FOR WHEEL CHAIR

RAMPQMADA/xxx Inches 7.0 \$6.67

• Substitute "xxx" by the linear foot of ramp needed for the mobile system Ex. : RAMPQM/360

RAILS KIT QUADRAMOBILE ON FLOOR

23.621.035.01 - - - \$85.00

KIT STOPPER PLATE FOR QUADRAMOBIL FLOOR

23.621.036.01 - - - \$40.00

QUADRAMOBILE SWIVEL HANDLE

00.620.075.01 - - - 2.3 \$168.00

LOCKING PIN

00.620.031.01 - - - 0.8 \$40.10

FLOOR TYPE LOCKING DEVICE

QMQLLOCK - - 40 40.0 \$175.00



STEEL BACK PANELS

Single face

QUADRAMOBILE

| CODE # | | | | W | D | H | lbs | \$ |
|-----------------|-----------|-----------|-----------|----|---|----|------|-----------------|
| LEFT | CENTER | RIGHT | UNIQUE | | | | | |
| 312.101/ | 312.100/ | 312.103/ | 312.102/ | | | | | |
| 305.076 | 300.076 | 305.076 | 312.076 | 30 | - | 76 | 27.9 | \$176.80 |
| 365.076** | 360.076** | 365.076** | 372.076** | 36 | - | 76 | 33.0 | \$203.00 |
| 400.076 | 393.076 | 400.076 | 405.076 | 39 | - | 76 | 35.8 | \$211.50 |
| 425.076** | 420.076** | 425.076** | 432.076** | 42 | - | 76 | 38.0 | \$215.00 |
| 485.076 | 480.076 | 485.076 | 492.076 | 48 | - | 76 | 43.1 | \$252.40 |
| 76" HIGH | | | | | | | | |
| 305.085 | 300.085 | 305.085 | 312.085 | 30 | - | 85 | 31.0 | \$184.50 |
| 365.085** | 360.085** | 365.085** | 372.085** | 36 | - | 85 | 36.6 | \$213.60 |
| 400.085 | 393.085 | 400.085 | 405.085 | 39 | - | 85 | 39.8 | \$221.40 |
| 425.085** | 420.085** | 425.085** | 432.085** | 42 | - | 85 | 42.3 | \$227.40 |
| 485.085 | 480.085 | 485.085 | 492.085 | 48 | - | 85 | 47.9 | \$265.40 |
| 85" HIGH | | | | | | | | |
| 305.088 | 300.088 | 305.088 | 312.088 | 30 | - | 88 | 32.1 | \$187.10 |
| 365.088** | 360.088** | 365.088** | 372.088** | 36 | - | 88 | 37.9 | \$215.00 |
| 400.088 | 393.088 | 400.088 | 405.088 | 39 | - | 88 | 41.1 | \$224.70 |
| 425.088** | 420.088** | 425.088** | 432.088** | 42 | - | 88 | 43.7 | \$228.00 |
| 485.088 | 480.088 | 485.088 | 492.088 | 48 | - | 88 | 49.5 | \$269.70 |
| 88" HIGH | | | | | | | | |

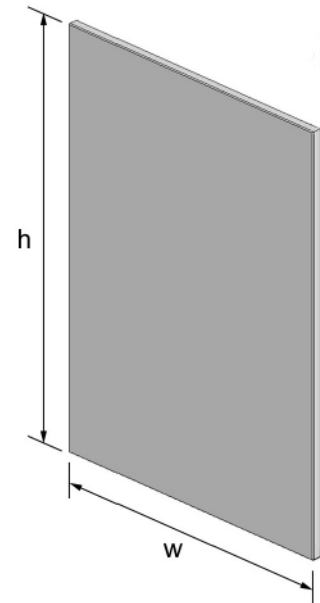

Notes :
 ** Available on QuickShip program (see **QuickShip** tab)



Issued 06-01-2005

QM/29

STEEL FRONT PANEL

Fixed section - Single face

QUADRAMOBILE

| | CODE # | W | D | H | lbs | \$ |
|----------|-------------------|----|---|----|------|-----------------|
| 76" HIGH | 240.139/120.076** | 12 | - | 76 | 16.1 | \$92.30 |
| | 240.139/130.076 | 13 | - | 76 | 16.9 | \$93.50 |
| | 240.139/150.076** | 15 | - | 76 | 18.6 | \$96.00 |
| | 240.139/160.076 | 16 | - | 76 | 19.5 | \$97.30 |
| 85" HIGH | 240.139/120.085** | 12 | - | 85 | 17.7 | \$98.30 |
| | 240.139/130.085 | 13 | - | 85 | 18.6 | \$99.70 |
| | 240.139/150.085** | 15 | - | 85 | 20.5 | \$102.70 |
| | 240.139/160.085 | 16 | - | 85 | 21.4 | \$104.20 |
| 88" HIGH | 240.139/120.088** | 12 | - | 88 | 18.2 | \$100.30 |
| | 240.139/130.088 | 13 | - | 88 | 19.2 | \$101.80 |
| | 240.139/150.088** | 15 | - | 88 | 21.1 | \$104.90 |
| | 240.139/160.088 | 16 | - | 88 | 22.1 | \$106.50 |

Notes :
** Available on QuickShip program (see **QuickShip** tab)

QM/30

Issued 06-01-2005



STEEL FRONT PANEL

Fixed section - Double face

QUADRAMOBILE

| | CODE # | W | D | H | lbs | \$ |
|----------|-------------------|----|---|----|------|-----------------|
| 76" HIGH | 240.139/240.076** | 24 | - | 76 | 26.3 | \$159.00 |
| | 240.139/260.076 | 26 | - | 76 | 27.2 | \$161.10 |
| | 240.139/300.076** | 30 | - | 76 | 29.0 | \$165.40 |
| | 240.139/320.076 | 32 | - | 76 | 29.9 | \$165.70 |
| 85" HIGH | 240.139/240.085** | 24 | - | 85 | 31.4 | \$170.90 |
| | 240.139/260.085 | 26 | - | 85 | 32.5 | \$173.50 |
| | 240.139/300.085** | 30 | - | 85 | 34.6 | \$178.70 |
| | 240.139/320.085 | 32 | - | 85 | 35.7 | \$181.20 |
| 85" HIGH | 240.139/240.088** | 24 | - | 88 | 33.1 | \$174.90 |
| | 240.139/260.088 | 26 | - | 88 | 34.2 | \$177.70 |
| | 240.139/300.088** | 30 | - | 88 | 36.5 | \$183.10 |
| | 240.139/320.088 | 32 | - | 88 | 37.7 | \$185.80 |

Notes :

** Available on QuickShip program (see **QuickShip** tab)



Issued 06-01-2005

QM/31

STEEL FRONT PANEL
 Mechanical section - Single face

QUADRAMOBILE

| | CODE # | W | D | H | lbs | \$ |
|----------|-----------------|----|---|----|------|-----------------|
| 76" HIGH | 240.140/120.076 | 12 | - | 76 | 16.1 | \$92.30 |
| | 240.140/130.076 | 13 | - | 76 | 16.6 | \$93.50 |
| | 240.140/150.076 | 15 | - | 76 | 17.7 | \$96.00 |
| | 240.140/160.076 | 16 | - | 76 | 18.2 | \$97.30 |
| 85" HIGH | 240.140/120.085 | 12 | - | 85 | 18.6 | \$98.30 |
| | 240.140/130.085 | 13 | - | 85 | 19.2 | \$99.70 |
| | 240.140/150.085 | 15 | - | 85 | 20.5 | \$102.70 |
| | 240.140/160.085 | 16 | - | 85 | 21.1 | \$104.20 |
| 88" HIGH | 240.140/120.088 | 12 | - | 88 | 19.5 | \$100.30 |
| | 240.140/130.088 | 13 | - | 88 | 20.1 | \$101.80 |
| | 240.140/150.088 | 15 | - | 88 | 21.4 | \$104.90 |
| | 240.140/160.088 | 16 | - | 88 | 22.1 | \$106.50 |

Notes :
 • Handle is not included with the panel

QM/32

Issued 06-01-2005



STEEL FRONT PANEL
 Mechanical section - Double face

QUADRAMOBILE

| | CODE # | W | D | H | lbs | \$ |
|----------|-----------------|----|---|----|------|-----------------|
| 76" HIGH | 240.138/240.076 | 24 | - | 76 | 26.3 | \$159.00 |
| | 240.138/260.076 | 26 | - | 76 | 27.2 | \$161.10 |
| | 240.138/300.076 | 30 | - | 76 | 29.0 | \$165.40 |
| | 240.138/320.076 | 32 | - | 76 | 29.9 | \$165.70 |
| 85" HIGH | 240.138/240.085 | 24 | - | 85 | 31.4 | \$170.90 |
| | 240.138/260.085 | 26 | - | 85 | 32.5 | \$173.50 |
| | 240.138/300.085 | 30 | - | 85 | 34.6 | \$178.70 |
| | 240.138/320.085 | 32 | - | 85 | 35.7 | \$181.20 |
| 88" HIGH | 240.138/240.088 | 24 | - | 88 | 33.1 | \$174.90 |
| | 240.138/260.088 | 26 | - | 88 | 34.2 | \$177.70 |
| | 240.138/300.088 | 30 | - | 88 | 36.5 | \$183.10 |
| | 240.138/320.088 | 32 | - | 88 | 37.7 | \$185.80 |

Notes :
 • Handle is not included with the panel



QM/33

Issued 06-01-2005



CARRIAGE ONLY

Fixed section - starter single face

QUADRAMOBILE

| | CODE # | W | D | H | lbs | \$ |
|--------------|---------------|----|----|---|------|----------|
| 30" WIDE | QMSFCH.FS3012 | 30 | 12 | 3 | 17.9 | \$446.00 |
| | QMSFCH.FS3013 | 30 | 13 | 3 | 18.7 | \$448.00 |
| | QMSFCH.FS3015 | 30 | 15 | 3 | 20.4 | \$452.00 |
| | QMSFCH.FS3016 | 30 | 16 | 3 | 21.1 | \$453.00 |
| 36" WIDE | QMSFCH.FS3612 | 36 | 12 | 3 | 19.2 | \$448.00 |
| | QMSFCH.FS3613 | 36 | 13 | 3 | 20.0 | \$451.00 |
| | QMSFCH.FS3615 | 36 | 15 | 3 | 21.7 | \$454.00 |
| | QMSFCH.FS3616 | 36 | 16 | 3 | 22.5 | \$456.00 |
| 39 3/8" WIDE | QMSFCH.FS3912 | 39 | 12 | 3 | 20.0 | \$451.00 |
| | QMSFCH.FS3913 | 39 | 13 | 3 | 20.8 | \$452.00 |
| | QMSFCH.FS3915 | 39 | 15 | 3 | 22.4 | \$456.00 |
| | QMSFCH.FS3916 | 39 | 16 | 3 | 23.2 | \$457.00 |
| 42" WIDE | QMSFCH.FS4212 | 42 | 12 | 3 | 20.6 | \$452.00 |
| | QMSFCH.FS4213 | 42 | 13 | 3 | 21.4 | \$453.00 |
| | QMSFCH.FS4215 | 42 | 15 | 3 | 23.0 | \$457.00 |
| | QMSFCH.FS4216 | 42 | 16 | 3 | 23.8 | \$459.00 |
| 48" WIDE | QMSFCH.FS4812 | 48 | 12 | 3 | 21.9 | \$454.00 |
| | QMSFCH.FS4813 | 48 | 13 | 3 | 22.7 | \$456.00 |
| | QMSFCH.FS4815 | 48 | 15 | 3 | 24.3 | \$459.00 |
| | QMSFCH.FS4816 | 48 | 16 | 3 | 25.1 | \$461.00 |

QM/34

Issued 06-01-2005



CARRIAGE ONLY

Fixed section - adder single face

QUADRAMOBILE

| | CODE # | W | D | H | lbs | \$ |
|--------------|---------------|----|----|---|------|----------|
| 30" WIDE | QMSFCH.FA3012 | 30 | 12 | 3 | 13.2 | \$273.00 |
| | QMSFCH.FA3013 | 30 | 13 | 3 | 13.7 | \$274.00 |
| | QMSFCH.FA3015 | 30 | 15 | 3 | 14.7 | \$276.00 |
| | QMSFCH.FA3016 | 30 | 16 | 3 | 15.2 | \$277.00 |
| 36" WIDE | QMSFCH.FA3612 | 36 | 12 | 3 | 14.5 | \$275.00 |
| | QMSFCH.FA3613 | 36 | 13 | 3 | 15.0 | \$276.00 |
| | QMSFCH.FA3615 | 36 | 15 | 3 | 16.0 | \$278.00 |
| | QMSFCH.FA3616 | 36 | 16 | 3 | 16.5 | \$279.00 |
| 39 3/8" WIDE | QMSFCH.FA3912 | 39 | 12 | 3 | 15.2 | \$276.00 |
| | QMSFCH.FA3913 | 39 | 13 | 3 | 15.7 | \$277.00 |
| | QMSFCH.FA3915 | 39 | 15 | 3 | 16.8 | \$279.00 |
| | QMSFCH.FA3916 | 39 | 16 | 3 | 17.3 | \$281.00 |
| 42" WIDE | QMSFCH.FA4212 | 42 | 12 | 3 | 15.8 | \$277.00 |
| | QMSFCH.FA4213 | 42 | 13 | 3 | 16.3 | \$278.00 |
| | QMSFCH.FA4215 | 42 | 15 | 3 | 17.4 | \$281.00 |
| | QMSFCH.FA4216 | 42 | 16 | 3 | 17.9 | \$283.00 |
| 48" WIDE | QMSFCH.FA4812 | 48 | 12 | 3 | 17.1 | \$281.00 |
| | QMSFCH.FA4813 | 48 | 13 | 3 | 17.6 | \$282.00 |
| | QMSFCH.FA4815 | 48 | 15 | 3 | 18.7 | \$283.00 |
| | QMSFCH.FA4816 | 48 | 16 | 3 | 19.2 | \$284.00 |

CARRIAGE ONLY

Fixed section - starter double face

QUADRAMOBILE

| | CODE # | W | D | H | lbs | \$ |
|--------------|---------------|----|----|---|------|----------|
| 30" WIDE | QMSFCH.FS3024 | 30 | 24 | 3 | 22.3 | \$466.00 |
| | QMSFCH.FS3026 | 30 | 26 | 3 | 23.4 | \$470.00 |
| | QMSFCH.FS3030 | 30 | 30 | 3 | 26.0 | \$475.00 |
| | QMSFCH.FS3032 | 30 | 32 | 3 | 27.2 | \$478.00 |
| 36" WIDE | QMSFCH.FS3624 | 36 | 24 | 3 | 23.6 | \$468.00 |
| | QMSFCH.FS3626 | 36 | 26 | 3 | 24.8 | \$473.00 |
| | QMSFCH.FS3630 | 36 | 30 | 3 | 27.3 | \$478.00 |
| | QMSFCH.FS3632 | 36 | 32 | 3 | 28.5 | \$481.00 |
| 39 3/8" WIDE | QMSFCH.FS3924 | 39 | 24 | 3 | 24.4 | \$469.00 |
| | QMSFCH.FS3926 | 39 | 26 | 3 | 25.5 | \$474.00 |
| | QMSFCH.FS3930 | 39 | 30 | 3 | 28.0 | \$480.00 |
| | QMSFCH.FS3932 | 39 | 32 | 3 | 29.2 | \$483.00 |
| 42" WIDE | QMSFCH.FS4224 | 42 | 24 | 3 | 24.9 | \$471.00 |
| | QMSFCH.FS4226 | 42 | 26 | 3 | 26.1 | \$476.00 |
| | QMSFCH.FS4230 | 42 | 30 | 3 | 28.6 | \$481.00 |
| | QMSFCH.FS4232 | 42 | 32 | 3 | 29.8 | \$484.00 |
| 48" WIDE | QMSFCH.FS4824 | 48 | 24 | 3 | 26.3 | \$474.00 |
| | QMSFCH.FS4826 | 48 | 26 | 3 | 27.4 | \$478.00 |
| | QMSFCH.FS4830 | 48 | 30 | 3 | 29.9 | \$484.00 |
| | QMSFCH.FS4832 | 48 | 32 | 3 | 31.1 | \$486.00 |

QM/36

Issued 06-01-2005



CARRIAGE ONLY

Fixed section - adder double face

QUADRAMOBILE

| | CODE # | W | D | H | lbs | \$ |
|--------------|---------------|----|----|---|------|-----------------|
| 30" WIDE | QMSFCH.FA3024 | 30 | 24 | 3 | 17.9 | \$282.00 |
| | QMSFCH.FA3026 | 30 | 26 | 3 | 18.8 | \$284.00 |
| | QMSFCH.FA3030 | 30 | 30 | 3 | 20.6 | \$287.00 |
| | QMSFCH.FA3032 | 30 | 32 | 3 | 21.5 | \$289.00 |
| 36" WIDE | QMSFCH.FA3624 | 36 | 24 | 3 | 19.2 | \$285.00 |
| | QMSFCH.FA3626 | 36 | 26 | 3 | 20.1 | \$287.00 |
| | QMSFCH.FA3630 | 36 | 30 | 3 | 21.9 | \$291.00 |
| | QMSFCH.FA3632 | 36 | 32 | 3 | 22.8 | \$292.00 |
| 39 3/8" WIDE | QMSFCH.FA3924 | 39 | 24 | 3 | 20.0 | \$286.00 |
| | QMSFCH.FA3926 | 39 | 26 | 3 | 20.8 | \$288.00 |
| | QMSFCH.FA3930 | 39 | 30 | 3 | 22.6 | \$292.00 |
| | QMSFCH.FA3932 | 39 | 32 | 3 | 23.5 | \$294.00 |
| 42" WIDE | QMSFCH.FA4224 | 42 | 24 | 3 | 20.5 | \$287.00 |
| | QMSFCH.FA4226 | 42 | 26 | 3 | 21.4 | \$289.00 |
| | QMSFCH.FA4230 | 42 | 30 | 3 | 23.2 | \$293.00 |
| | QMSFCH.FA4232 | 42 | 32 | 3 | 24.1 | \$295.00 |
| 48" WIDE | QMSFCH.FA4824 | 48 | 24 | 3 | 21.9 | \$291.00 |
| | QMSFCH.FA4826 | 48 | 26 | 3 | 22.7 | \$292.00 |
| | QMSFCH.FA4830 | 48 | 30 | 3 | 24.5 | \$296.00 |
| | QMSFCH.FA4832 | 48 | 32 | 3 | 25.4 | \$297.00 |

CARRIAGE ONLY

Mobile section - starter single face

QUADRAMOBILE

| | CODE # | W | D | H | lbs | \$ |
|--------------|-----------------|----|----|---|------|----------|
| 30" WIDE | QMSFCH.MSSF3012 | 30 | 12 | 3 | 17.9 | \$657.00 |
| | QMSFCH.MSSF3013 | 30 | 13 | 3 | 18.7 | \$658.00 |
| | QMSFCH.MSSF3015 | 30 | 15 | 3 | 20.4 | \$662.00 |
| | QMSFCH.MSSF3016 | 30 | 16 | 3 | 21.1 | \$663.00 |
| 36" WIDE | QMSFCH.MSSF3612 | 36 | 12 | 3 | 19.2 | \$667.00 |
| | QMSFCH.MSSF3613 | 36 | 13 | 3 | 20.0 | \$668.00 |
| | QMSFCH.MSSF3615 | 36 | 15 | 3 | 21.7 | \$672.00 |
| | QMSFCH.MSSF3616 | 36 | 16 | 3 | 22.5 | \$674.00 |
| 39 3/8" WIDE | QMSFCH.MSSF3912 | 39 | 12 | 3 | 20.0 | \$672.00 |
| | QMSFCH.MSSF3913 | 39 | 13 | 3 | 20.8 | \$673.00 |
| | QMSFCH.MSSF3915 | 39 | 15 | 3 | 22.4 | \$677.00 |
| | QMSFCH.MSSF3916 | 39 | 16 | 3 | 23.2 | \$679.00 |
| 42" WIDE | QMSFCH.MSSF4212 | 42 | 12 | 3 | 20.6 | \$677.00 |
| | QMSFCH.MSSF4213 | 42 | 13 | 3 | 21.4 | \$679.00 |
| | QMSFCH.MSSF4215 | 42 | 15 | 3 | 23.0 | \$683.00 |
| | QMSFCH.MSSF4216 | 42 | 16 | 3 | 23.8 | \$685.00 |
| 48" WIDE | QMSFCH.MSSF4812 | 48 | 12 | 3 | 21.9 | \$693.00 |
| | QMSFCH.MSSF4813 | 48 | 13 | 3 | 22.7 | \$694.00 |
| | QMSFCH.MSSF4815 | 48 | 15 | 3 | 24.3 | \$697.00 |
| | QMSFCH.MSSF4816 | 48 | 16 | 3 | 25.1 | \$699.00 |

QM/38

Issued 06-01-2005

MONTEL AETNASTAK



Schedule

Contract OS-28F-0017M

CARRIAGE ONLY

Mobile section - adder single face

QUADRAMOBILE

| | CODE # | W | D | H | lbs | \$ |
|--------------|-----------------|----|----|---|------|----------|
| 30" WIDE | QMSFCH.MASF3012 | 30 | 12 | 3 | 13.1 | \$391.00 |
| | QMSFCH.MASF3013 | 30 | 13 | 3 | 13.6 | \$392.00 |
| | QMSFCH.MASF3015 | 30 | 15 | 3 | 14.7 | \$393.00 |
| | QMSFCH.MASF3016 | 30 | 16 | 3 | 15.2 | \$396.00 |
| 36" WIDE | QMSFCH.MASF3612 | 36 | 12 | 3 | 14.4 | \$399.00 |
| | QMSFCH.MASF3613 | 36 | 13 | 3 | 15.0 | \$401.00 |
| | QMSFCH.MASF3615 | 36 | 15 | 3 | 16.0 | \$403.00 |
| | QMSFCH.MASF3616 | 36 | 16 | 3 | 16.5 | \$404.00 |
| 39 3/8" WIDE | QMSFCH.MASF3912 | 39 | 12 | 3 | 15.2 | \$405.00 |
| | QMSFCH.MASF3913 | 39 | 13 | 3 | 15.7 | \$406.00 |
| | QMSFCH.MASF3915 | 39 | 15 | 3 | 16.7 | \$407.00 |
| | QMSFCH.MASF3916 | 39 | 16 | 3 | 17.2 | \$408.00 |
| 42" WIDE | QMSFCH.MASF4212 | 42 | 12 | 3 | 15.8 | \$411.00 |
| | QMSFCH.MASF4213 | 42 | 13 | 3 | 16.3 | \$412.00 |
| | QMSFCH.MASF4215 | 42 | 15 | 3 | 17.3 | \$414.00 |
| | QMSFCH.MASF4216 | 42 | 16 | 3 | 17.8 | \$415.00 |
| 48" WIDE | QMSFCH.MASF4812 | 48 | 12 | 3 | 17.1 | \$419.00 |
| | QMSFCH.MASF4813 | 48 | 13 | 3 | 17.6 | \$421.00 |
| | QMSFCH.MASF4815 | 48 | 15 | 3 | 18.6 | \$424.00 |
| | QMSFCH.MASF4816 | 48 | 16 | 3 | 19.1 | \$425.00 |



Issued 06-01-2005

QM/39

CARRIAGE ONLY

Mobile section - starter double face

QUADRAMOBILE

| | CODE # | W | D | H | lbs | \$ |
|--------------|-----------------|----|----|---|------|----------|
| 30" WIDE | QMSFCH.MSDF3024 | 30 | 24 | 3 | 22.0 | \$651.00 |
| | QMSFCH.MSDF3026 | 30 | 26 | 3 | 23.1 | \$653.00 |
| | QMSFCH.MSDF3030 | 30 | 30 | 3 | 25.6 | \$658.00 |
| | QMSFCH.MSDF3032 | 30 | 32 | 3 | 26.8 | \$660.00 |
| 36" WIDE | QMSFCH.MSDF3624 | 36 | 24 | 3 | 23.3 | \$661.00 |
| | QMSFCH.MSDF3626 | 36 | 26 | 3 | 24.4 | \$663.00 |
| | QMSFCH.MSDF3630 | 36 | 30 | 3 | 27.0 | \$668.00 |
| | QMSFCH.MSDF3632 | 36 | 32 | 3 | 28.2 | \$671.00 |
| 39 3/8" WIDE | QMSFCH.MSDF3924 | 39 | 24 | 3 | 24.1 | \$666.00 |
| | QMSFCH.MSDF3926 | 39 | 26 | 3 | 25.2 | \$672.00 |
| | QMSFCH.MSDF3930 | 39 | 30 | 3 | 27.7 | \$673.00 |
| | QMSFCH.MSDF3932 | 39 | 32 | 3 | 28.9 | \$676.00 |
| 42" WIDE | QMSFCH.MSDF4224 | 42 | 24 | 3 | 24.6 | \$672.00 |
| | QMSFCH.MSDF4226 | 42 | 26 | 3 | 25.8 | \$674.00 |
| | QMSFCH.MSDF4230 | 42 | 30 | 3 | 28.3 | \$679.00 |
| | QMSFCH.MSDF4232 | 42 | 32 | 3 | 29.5 | \$682.00 |
| 48" WIDE | QMSFCH.MSDF4824 | 48 | 24 | 3 | 25.9 | \$687.00 |
| | QMSFCH.MSDF4826 | 48 | 26 | 3 | 27.1 | \$689.00 |
| | QMSFCH.MSDF4830 | 48 | 30 | 3 | 29.6 | \$694.00 |
| | QMSFCH.MSDF4832 | 48 | 32 | 3 | 30.8 | \$696.00 |

QM/40

Issued 06-01-2005



CARRIAGE ONLY

Mobile section - adder double face

QUADRAMOBILE

| | CODE # | W | D | H | lbs | \$ |
|--------------|-----------------|----|----|---|------|----------|
| 30" WIDE | QMSFCH.MADF3024 | 30 | 24 | 3 | 17.9 | \$402.00 |
| | QMSFCH.MADF3026 | 30 | 26 | 3 | 18.8 | \$403.00 |
| | QMSFCH.MADF3030 | 30 | 30 | 3 | 20.6 | \$407.00 |
| | QMSFCH.MADF3032 | 30 | 32 | 3 | 21.5 | \$408.00 |
| 36" WIDE | QMSFCH.MADF3624 | 36 | 24 | 3 | 19.2 | \$408.00 |
| | QMSFCH.MADF3626 | 36 | 26 | 3 | 20.1 | \$411.00 |
| | QMSFCH.MADF3630 | 36 | 30 | 3 | 21.9 | \$415.00 |
| | QMSFCH.MADF3632 | 36 | 32 | 3 | 22.8 | \$417.00 |
| 39 3/8" WIDE | QMSFCH.MADF3924 | 39 | 24 | 3 | 20.0 | \$415.00 |
| | QMSFCH.MADF3926 | 39 | 26 | 3 | 20.8 | \$416.00 |
| | QMSFCH.MADF3930 | 39 | 30 | 3 | 22.6 | \$419.00 |
| | QMSFCH.MADF3932 | 39 | 32 | 3 | 23.5 | \$422.00 |
| 42" WIDE | QMSFCH.MADF4224 | 42 | 24 | 3 | 20.5 | \$421.00 |
| | QMSFCH.MADF4226 | 42 | 26 | 3 | 21.4 | \$422.00 |
| | QMSFCH.MADF4230 | 42 | 30 | 3 | 23.2 | \$426.00 |
| | QMSFCH.MADF4232 | 42 | 32 | 3 | 24.1 | \$427.00 |
| 48" WIDE | QMSFCH.MADF4824 | 48 | 24 | 3 | 21.9 | \$429.00 |
| | QMSFCH.MADF4826 | 48 | 26 | 3 | 22.7 | \$432.00 |
| | QMSFCH.MADF4830 | 48 | 30 | 3 | 24.5 | \$435.00 |
| | QMSFCH.MADF4832 | 48 | 32 | 3 | 25.4 | \$437.00 |



Issued 06-01-2005

QM/41

PLAIN SUPPORTED SHELF ASSEMBLY KIT

Single face - 22 gauge

QUADRAMOBILE

| | CODE # | W | D | r* | lbs | \$ |
|--------------|-------------|----|----|----|------|---------|
| 30" WIDE | QS3012SFA | 30 | 12 | - | 6.3 | \$40.50 |
| | QS3013SFA | 30 | 13 | - | 6.6 | \$41.20 |
| | QS3015SFA | 30 | 15 | - | 7.2 | \$42.50 |
| | QS3016SFA | 30 | 16 | - | 7.5 | \$43.20 |
| 36" WIDE | QS3612SFA** | 36 | 12 | - | 7.6 | \$43.30 |
| | QS3613SFA | 36 | 13 | - | 7.9 | \$44.10 |
| | QS3615SFA** | 36 | 15 | - | 8.6 | \$45.70 |
| | QS3616SFA | 36 | 16 | - | 8.9 | \$46.50 |
| 39 3/8" WIDE | QS3912SFA | 39 | 12 | - | 8.2 | \$45.20 |
| | QS3913SFA | 39 | 13 | - | 8.5 | \$46.10 |
| | QS3915SFA | 39 | 15 | - | 9.3 | \$47.80 |
| | QS3916SFA | 39 | 16 | - | 9.6 | \$48.70 |
| 42" WIDE | QS4212SFA** | 42 | 12 | - | 8.8 | \$46.70 |
| | QS4213SFA | 42 | 13 | - | 9.2 | \$47.60 |
| | QS4215SFA** | 42 | 15 | - | 9.9 | \$49.50 |
| | QS4216SFA | 42 | 16 | - | 10.3 | \$50.40 |
| 48" WIDE | QS4812SFA | 48 | 12 | - | 10.0 | \$50.90 |
| | QS4813SFA | 48 | 13 | - | 10.4 | \$52.00 |
| | QS4815SFA | 48 | 15 | - | 11.3 | \$54.00 |
| | QS4816SFA | 48 | 16 | - | 11.8 | \$55.10 |

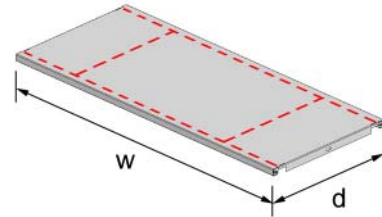

Notes :

- 4-bend 3/4" thick shelf
- 22 gauge
- Two shelf supports and necessary reinforcements included
- r* Quantity of shelf reinforcements included per assembly
- ** Available on QuickShip program (see **QuickShip** tab)

QM/42

Issued 06-01-2005

MONTEL AETNASTAK

GSA Schedule
Contract GS-28F-8817M

PLAIN SUPPORTED SHELF ASSEMBLY KIT

Double face full depth - 22 gauge

QUADRAMOBILE

| | CODE # | W | D | r* | lbs | \$ |
|--------------|-------------|----|----|----|------|---------|
| 30" WIDE | QS3024DFA | 30 | 24 | 1 | 11.0 | \$53.80 |
| | QS3026DFA | 30 | 26 | 1 | 11.7 | \$55.30 |
| | QS3030DFA | 30 | 30 | 2 | 14.5 | \$64.40 |
| | QS3032DFA | 30 | 32 | 2 | 15.3 | \$66.10 |
| 36" WIDE | QS3624DFA** | 36 | 24 | 1 | 12.8 | \$58.20 |
| | QS3626DFA | 36 | 26 | 2 | 14.9 | \$65.50 |
| | QS3630DFA** | 36 | 30 | 2 | 16.6 | \$69.50 |
| | QS3632DFA | 36 | 32 | 2 | 17.5 | \$71.40 |
| 39 3/8" WIDE | QS3924DFA | 39 | 24 | 2 | 14.9 | \$66.40 |
| | QS3926DFA | 39 | 26 | 2 | 15.8 | \$68.50 |
| | QS3930DFA | 39 | 30 | 2 | 17.7 | \$72.70 |
| | QS3932DFA | 39 | 32 | 2 | 18.6 | \$74.80 |
| 42" WIDE | QS4224DFA** | 42 | 24 | 2 | 15.8 | \$68.50 |
| | QS4226DFA | 42 | 26 | 2 | 16.8 | \$70.70 |
| | QS4230DFA** | 42 | 30 | 2 | 18.8 | \$75.20 |
| | QS4232DFA | 42 | 32 | 2 | 19.8 | \$77.20 |
| 48" WIDE | QS4824DFA | 48 | 24 | 2 | 17.7 | \$74.20 |
| | QS4826DFA | 48 | 26 | 2 | 18.7 | \$76.70 |
| | QS4830DFA | 48 | 30 | 3 | 22.4 | \$87.70 |
| | QS4832DFA | 48 | 32 | 3 | 23.6 | \$90.40 |

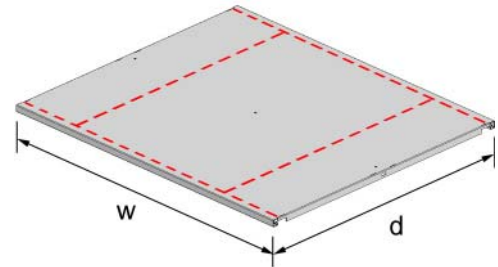

Notes :

- 4-bend 3/4" thick shelf
- 22 gauge
- Two shelf supports and necessary reinforcements included
- r* Quantity of shelf reinforcements included per assembly
- ** Available on QuickShip program (see **QuickShip** tab)

SLOTTED SUPPORTED SHELF ASSEMBLY KIT

Single face - 22 gauge

QUADRAMOBILE

| | CODE # | W | D | r* | lbs | \$ |
|--------------|--------------|----|----|----|------|---------|
| 30" WIDE | QSS3012SFA | 30 | 12 | - | 6.3 | \$40.90 |
| | QSS3013SFA | 30 | 13 | - | 6.6 | \$41.50 |
| | QSS3015SFA | 30 | 15 | - | 7.2 | \$42.90 |
| | QSS3016SFA | 30 | 16 | - | 7.5 | \$43.50 |
| 36" WIDE | QSS3612SFA** | 36 | 12 | - | 7.6 | \$43.70 |
| | QSS3613SFA | 36 | 13 | - | 7.9 | \$44.50 |
| | QSS3615SFA** | 36 | 15 | - | 8.6 | \$46.00 |
| | QSS3616SFA | 36 | 16 | - | 8.9 | \$46.80 |
| 39 3/8" WIDE | QSS3912SFA | 39 | 12 | - | 8.2 | \$45.60 |
| | QSS3913SFA | 39 | 13 | - | 8.5 | \$46.50 |
| | QSS3915SFA | 39 | 15 | - | 9.3 | \$48.20 |
| | QSS3916SFA | 39 | 16 | - | 9.6 | \$49.00 |
| 42" WIDE | QSS4212SFA** | 42 | 12 | - | 8.8 | \$47.10 |
| | QSS4213SFA | 42 | 13 | - | 9.2 | \$48.00 |
| | QSS4215SFA** | 42 | 15 | - | 9.9 | \$49.80 |
| | QSS4216SFA | 42 | 16 | - | 10.3 | \$50.70 |
| 48" WIDE | QSS4812SFA | 48 | 12 | - | 10.0 | \$51.30 |
| | QSS4813SFA | 48 | 13 | - | 10.4 | \$52.30 |
| | QSS4815SFA | 48 | 15 | - | 11.3 | \$54.40 |
| | QSS4816SFA | 48 | 16 | - | 11.8 | \$55.40 |

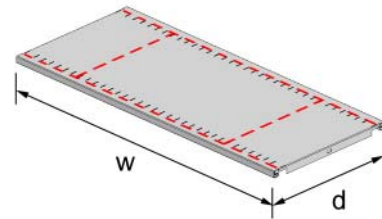

Notes :

- 4-bend 3/4" thick shelf
- 22 gauge
- Two shelf supports and necessary reinforcements included

r* Quantity of shelf reinforcements included per assembly
 ** Available on QuickShip program (see **QuickShip** tab)

QM/44

Issued 06-01-2005

MONTEL AETNASTAK

GSA Schedule
 Contract GS-28F-8817M

SLOTTED SUPPORTED SHELF ASSEMBLY KIT

Double face full depth - 22 gauge

QUADRAMOBILE

| | CODE # | W | D | r* | lbs | \$ |
|---------------------|--------------|----|----|----|------|----------------|
| 30" WIDE | QSS3024DFA | 30 | 24 | 1 | 11.0 | \$54.20 |
| | QSS3026DFA | 30 | 26 | 1 | 11.7 | \$55.70 |
| | QSS3030DFA | 30 | 30 | 2 | 14.5 | \$64.70 |
| | QSS3032DFA | 30 | 32 | 2 | 15.3 | \$66.40 |
| 36" WIDE | QSS3624DFA** | 36 | 24 | 1 | 12.8 | \$58.50 |
| | QSS3626DFA | 36 | 26 | 2 | 14.9 | \$65.90 |
| | QSS3630DFA** | 36 | 30 | 2 | 16.6 | \$69.80 |
| | QSS3632DFA | 36 | 32 | 2 | 17.5 | \$71.80 |
| 39 3/8" WIDE | QSS3924DFA | 39 | 24 | 2 | 14.9 | \$66.70 |
| | QSS3926DFA | 39 | 26 | 2 | 15.8 | \$68.80 |
| | QSS3930DFA | 39 | 30 | 2 | 17.7 | \$73.10 |
| | QSS3932DFA | 39 | 32 | 2 | 18.6 | \$75.20 |
| 42" WIDE | QSS4224DFA** | 42 | 24 | 2 | 15.8 | \$68.90 |
| | QSS4226DFA | 42 | 26 | 2 | 16.8 | \$71.10 |
| | QSS4230DFA** | 42 | 30 | 2 | 18.8 | \$75.50 |
| | QSS4232DFA | 42 | 32 | 2 | 19.8 | \$77.80 |
| 48" WIDE | QSS4824DFA | 48 | 24 | 2 | 17.7 | \$74.60 |
| | QSS4826DFA | 48 | 26 | 2 | 18.7 | \$77.10 |
| | QSS4830DFA | 48 | 30 | 3 | 22.4 | \$88.10 |
| | QSS4832DFA | 48 | 32 | 3 | 23.6 | \$90.80 |

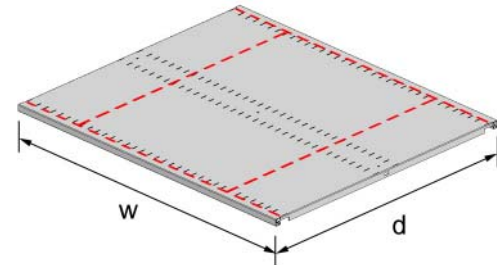

Notes :

- 4-bend 3/4" thick shelf
- 22 gauge
- Two shelf supports and necessary reinforcements included
- r* Quantity of shelf reinforcements included per assembly
- ** Available on QuickShip program (see **QuickShip** tab)



Issued 06-01-2005

QM/45

PLAIN SUPPORTED BOX SHELF ASSEMBLY KIT

Single face - 22 gauge

QUADRAMOBILE

| | CODE # | W | D | r* | lbs | \$ |
|--------------|------------|----|----|----|------|---------|
| 30" WIDE | QSF3012SFA | 30 | 12 | - | 10.3 | \$56.70 |
| | QSF3013SFA | 30 | 13 | - | 10.7 | \$57.90 |
| | QSF3015SFA | 30 | 15 | - | 11.7 | \$59.70 |
| | QSF3016SFA | 30 | 16 | - | 12.0 | \$61.00 |
| 36" WIDE | QSF3612SFA | 36 | 12 | - | 11.9 | \$60.40 |
| | QSF3613SFA | 36 | 13 | - | 12.4 | \$61.70 |
| | QSF3615SFA | 36 | 15 | - | 13.4 | \$63.80 |
| | QSF3616SFA | 36 | 16 | - | 13.8 | \$65.20 |
| 39 3/8" WIDE | QSF3912SFA | 39 | 12 | - | 12.7 | \$62.80 |
| | QSF3913SFA | 39 | 13 | - | 13.2 | \$64.20 |
| | QSF3915SFA | 39 | 15 | - | 14.3 | \$66.40 |
| | QSF3916SFA | 39 | 16 | - | 14.7 | \$67.90 |
| 42" WIDE | QSF4212SFA | 42 | 12 | - | 13.4 | \$64.70 |
| | QSF4213SFA | 42 | 13 | - | 14.0 | \$66.10 |
| | QSF4215SFA | 42 | 15 | - | 15.2 | \$68.50 |
| | QSF4216SFA | 42 | 16 | - | 15.6 | \$70.00 |
| 48" WIDE | QSF4812SFA | 48 | 12 | - | 15.0 | \$69.80 |
| | QSF4813SFA | 48 | 13 | - | 15.7 | \$71.40 |
| | QSF4815SFA | 48 | 15 | - | 16.9 | \$73.90 |
| | QSF4816SFA | 48 | 16 | - | 17.4 | \$75.60 |

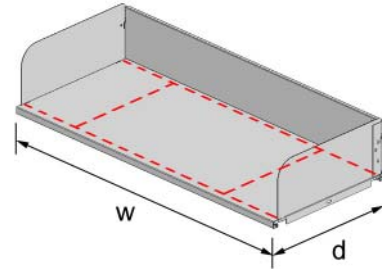

Notes :

- 4-bend 3/4" thick shelf
 - 22 gauge
 - Two shelf supports and necessary reinforcements included
 - Two 6" high end dividers included
 - 5 1/2" high plain backstop included
- r* Quantity of shelf reinforcements included per assembly

QM/46

Issued 06-01-2005

MONTEL AETNASTAK

GSA

Schedule

Contract GS-28F-8817M

PLAIN SUPPORTED BOX SHELF ASSEMBLY KIT

Double face full depth - 22 gauge

QUADRAMOBILE

| | CODE # | W | D | r* | lbs | \$ |
|---------------------|------------|----|----|----|------|-----------------|
| 30" WIDE | QSF3024DFA | 30 | 24 | 1 | 16.9 | \$75.60 |
| | QSF3026DFA | 30 | 26 | 1 | 18.0 | \$78.10 |
| | QSF3030DFA | 30 | 30 | 2 | 21.5 | \$88.20 |
| | QSF3032DFA | 30 | 32 | 2 | 22.4 | \$91.10 |
| 36" WIDE | QSF3624DFA | 36 | 24 | 1 | 19.1 | \$81.00 |
| | QSF3626DFA | 36 | 26 | 2 | 21.5 | \$89.30 |
| | QSF3630DFA | 36 | 30 | 2 | 24.0 | \$94.30 |
| | QSF3632DFA | 36 | 32 | 2 | 25.0 | \$97.40 |
| 39 3/8" WIDE | QSF3924DFA | 39 | 24 | 2 | 21.4 | \$89.70 |
| | QSF3926DFA | 39 | 26 | 2 | 22.7 | \$92.80 |
| | QSF3930DFA | 39 | 30 | 2 | 25.3 | \$98.00 |
| | QSF3932DFA | 39 | 32 | 2 | 26.3 | \$101.00 |
| 42" WIDE | QSF4224DFA | 42 | 24 | 2 | 22.5 | \$92.20 |
| | QSF4226DFA | 42 | 26 | 2 | 23.9 | \$95.40 |
| | QSF4230DFA | 42 | 30 | 2 | 26.5 | \$101.00 |
| | QSF4232DFA | 42 | 32 | 2 | 27.6 | \$104.00 |
| 48" WIDE | QSF4824DFA | 48 | 24 | 2 | 24.7 | \$98.80 |
| | QSF4826DFA | 48 | 26 | 2 | 26.2 | \$102.00 |
| | QSF4830DFA | 48 | 30 | 3 | 30.5 | \$114.00 |
| | QSF4832DFA | 48 | 32 | 3 | 31.8 | \$118.00 |

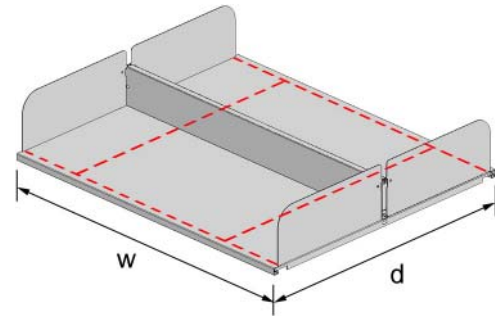

Notes :

- 4-bend 3/4" thick shelf
 - 22 gauge
 - Two shelf supports and necessary reinforcements included
 - Two 6" high end dividers included
 - 4 1/2" high plain centerstop included
- r* Quantity of shelf reinforcements included per assembly

SLOTTED SUPPORTED BOX SHELF ASSEMBLY KIT **QUADRAMOBILE**

Single face - 22 gauge

| | CODE # | W | D | r* | lbs | \$ |
|---------------------|------------|----|----|----|------|----------------|
| 30" WIDE | QSC3012SFA | 30 | 12 | - | 10.3 | \$57.30 |
| | QSC3013SFA | 30 | 13 | - | 10.7 | \$58.40 |
| | QSC3015SFA | 30 | 15 | - | 11.7 | \$60.30 |
| | QSC3016SFA | 30 | 16 | - | 12.0 | \$61.50 |
| 36" WIDE | QSC3612SFA | 36 | 12 | - | 11.9 | \$61.00 |
| | QSC3613SFA | 36 | 13 | - | 12.4 | \$62.30 |
| | QSC3615SFA | 36 | 15 | - | 13.4 | \$64.30 |
| | QSC3616SFA | 36 | 16 | - | 13.8 | \$65.70 |
| 39 3/8" WIDE | QSC3912SFA | 39 | 12 | - | 12.7 | \$63.40 |
| | QSC3913SFA | 39 | 13 | - | 13.2 | \$64.80 |
| | QSC3915SFA | 39 | 15 | - | 14.3 | \$67.00 |
| | QSC3916SFA | 39 | 16 | - | 14.7 | \$68.40 |
| 42" WIDE | QSC4212SFA | 42 | 12 | - | 13.4 | \$65.30 |
| | QSC4213SFA | 42 | 13 | - | 14.0 | \$66.70 |
| | QSC4215SFA | 42 | 15 | - | 15.2 | \$69.00 |
| | QSC4216SFA | 42 | 16 | - | 15.6 | \$70.50 |
| 48" WIDE | QSC4812SFA | 48 | 12 | - | 15.0 | \$70.40 |
| | QSC4813SFA | 48 | 13 | - | 15.7 | \$71.90 |
| | QSC4815SFA | 48 | 15 | - | 16.9 | \$74.50 |
| | QSC4816SFA | 48 | 16 | - | 17.4 | \$76.10 |

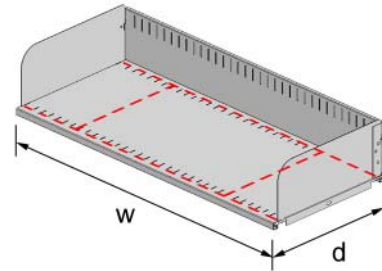

Notes :

- 4-bend 3/4" thick shelf
- 22 gauge
- Two shelf supports and necessary reinforcements included
- Two 6" high end dividers included
- 5 1/2" high slotted backstop included

r* Quantity of shelf reinforcements included per assembly

QM/48

Issued 06-01-2005



SLOTTED SUPPORTED BOX SHELF ASSEMBLY KIT **QUADRAMOBILE**

Double face full depth - 22 gauge

| | CODE # | W | D | r* | lbs | \$ |
|---------------------|------------|----|----|----|------|-----------------|
| 30" WIDE | QSC3024DFA | 30 | 24 | 1 | 16.9 | \$76.20 |
| | QSC3026DFA | 30 | 26 | 1 | 18.0 | \$78.70 |
| | QSC3030DFA | 30 | 30 | 2 | 21.5 | \$88.70 |
| | QSC3032DFA | 30 | 32 | 2 | 22.4 | \$91.60 |
| 36" WIDE | QSC3624DFA | 36 | 24 | 1 | 19.1 | \$81.40 |
| | QSC3626DFA | 36 | 26 | 2 | 21.5 | \$89.80 |
| | QSC3630DFA | 36 | 30 | 2 | 24.0 | \$94.70 |
| | QSC3632DFA | 36 | 32 | 2 | 25.0 | \$97.90 |
| 39 3/8" WIDE | QSC3924DFA | 39 | 24 | 2 | 21.4 | \$90.20 |
| | QSC3926DFA | 39 | 26 | 2 | 22.7 | \$93.30 |
| | QSC3930DFA | 39 | 30 | 2 | 25.3 | \$98.60 |
| | QSC3932DFA | 39 | 32 | 2 | 26.3 | \$102.00 |
| 42" WIDE | QSC4224DFA | 42 | 24 | 2 | 22.5 | \$92.80 |
| | QSC4226DFA | 42 | 26 | 2 | 23.9 | \$96.00 |
| | QSC4230DFA | 42 | 30 | 2 | 26.5 | \$101.00 |
| | QSC4232DFA | 42 | 32 | 2 | 27.6 | \$105.00 |
| 48" WIDE | QSC4824DFA | 48 | 24 | 2 | 24.7 | \$99.40 |
| | QSC4826DFA | 48 | 26 | 2 | 26.2 | \$103.00 |
| | QSC4830DFA | 48 | 30 | 3 | 30.5 | \$115.00 |
| | QSC4832DFA | 48 | 32 | 3 | 31.8 | \$119.00 |

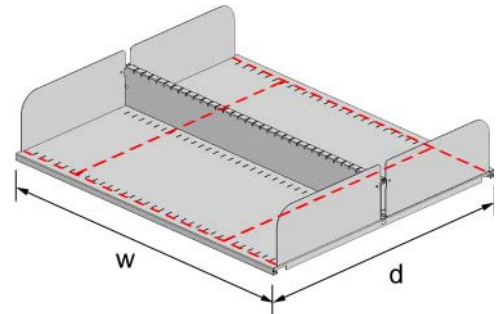

Notes :

- 4-bend 3/4" thick shelf
- 22 gauge
- Two shelf supports and necessary reinforcements included
- Two 6" high end dividers included
- 4 1/2" high slotted centerstop included

r* Quantity of shelf reinforcements included per assembly



Issued 06-01-2005

QM/49

CODE # W D H lbs \$

DIVIDER

| | | | | | |
|--------------|---|----|---|-----|---------------|
| QS.DIV6/12** | - | 12 | 6 | 0.7 | \$3.00 |
| QS.DIV6/13 | - | 13 | 6 | 0.8 | \$3.25 |
| QS.DIV6/15** | - | 15 | 6 | 0.9 | \$3.50 |
| QS.DIV6/16 | - | 16 | 6 | 1.0 | \$3.80 |

| | | | | | |
|------------|---|----|---|-----|---------------|
| QS.DIV9/12 | - | 12 | 9 | 0.9 | \$3.50 |
| QS.DIV9/13 | - | 13 | 9 | 1.0 | \$3.75 |
| QS.DIV9/15 | - | 15 | 9 | 1.2 | \$4.00 |
| QS.DIV9/16 | - | 16 | 9 | 1.3 | \$4.25 |

• Actual depth of divider is 1" less than the actual shelf depth. Ex. : **15" shelf = 14" divider**

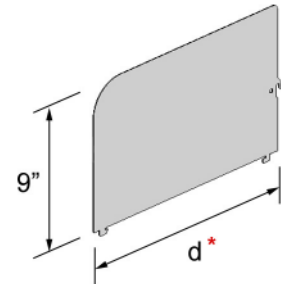
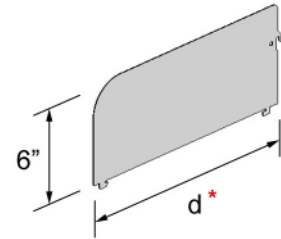

SLIDING REFERENCE SHELF

| | | | | | |
|----------------|----|----|---|------|-----------------|
| QS.BRES2412/12 | 24 | 11 | - | 9.0 | \$108.50 |
| QS.BRES2412/13 | 24 | 11 | - | 9.2 | \$108.80 |
| QS.BRES2412/15 | 24 | 11 | - | 9.4 | \$109.40 |
| QS.BRES2412/16 | 24 | 11 | - | 9.6 | \$109.70 |
| QS.BRES2412/24 | 24 | 11 | - | 10.2 | \$111.50 |
| QS.BRES2412/26 | 24 | 11 | - | 10.4 | \$111.80 |
| QS.BRES2412/30 | 24 | 11 | - | 10.6 | \$112.30 |
| QS.BRES2412/32 | 24 | 11 | - | 10.8 | \$112.60 |

| | | | | | |
|----------------|----|----|---|------|-----------------|
| QS.BRES2415/15 | 24 | 14 | - | 9.5 | \$112.00 |
| QS.BRES2415/16 | 24 | 14 | - | 9.7 | \$112.20 |
| QS.BRES2415/24 | 24 | 14 | - | 10.6 | \$113.80 |
| QS.BRES2415/26 | 24 | 14 | - | 10.8 | \$114.20 |
| QS.BRES2415/30 | 24 | 14 | - | 11.2 | \$115.00 |
| QS.BRES2415/32 | 24 | 14 | - | 11.4 | \$115.40 |

• The last 2 characters in QS.BRES2412/**12**, /**12** refer the depth of the section
 • Two shelf reinforcements included with each sliding reference shelf

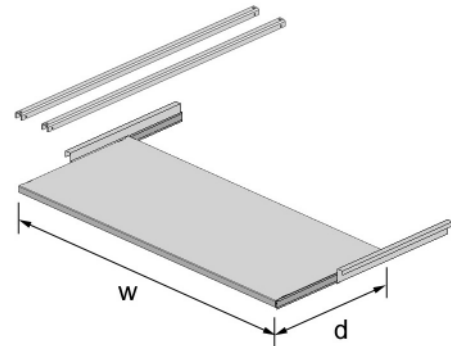

QM/50

Notes :

** Available on QuickShip program (see **QuickShip** tab)

CODE # W D H lbs \$

SLIDING REFERENCE SHELF

| | | | | | |
|------------------|----|----|---|------|----------|
| QS.BRES3012/12** | 30 | 11 | - | 10.0 | \$108.50 |
| QS.BRES3012/13 | 30 | 11 | - | 10.2 | \$108.80 |
| QS.BRES3012/15 | 30 | 11 | - | 10.4 | \$109.40 |
| QS.BRES3012/16 | 30 | 11 | - | 10.6 | \$109.70 |
| QS.BRES3012/24** | 30 | 11 | - | 11.2 | \$111.50 |
| QS.BRES3012/26 | 30 | 11 | - | 11.4 | \$111.80 |
| QS.BRES3012/30 | 30 | 11 | - | 11.8 | \$112.30 |
| QS.BRES3012/32 | 30 | 11 | - | 12.0 | \$112.60 |

| | | | | | |
|------------------|----|----|---|------|----------|
| QS.BRES3015/15** | 30 | 14 | - | 10.5 | \$112.00 |
| QS.BRES3015/16 | 30 | 14 | - | 10.7 | \$112.20 |
| QS.BRES3015/24 | 30 | 14 | - | 11.6 | \$113.80 |
| QS.BRES3015/26 | 30 | 14 | - | 11.8 | \$114.20 |
| QS.BRES3015/30** | 30 | 14 | - | 12.2 | \$115.00 |
| QS.BRES3015/32 | 30 | 14 | - | 12.4 | \$115.40 |

- The last 2 characters in QS.BRES2412/**12**, /**12** refer the depth of the section
- Two shelf reinforcements included with each sliding reference shelf

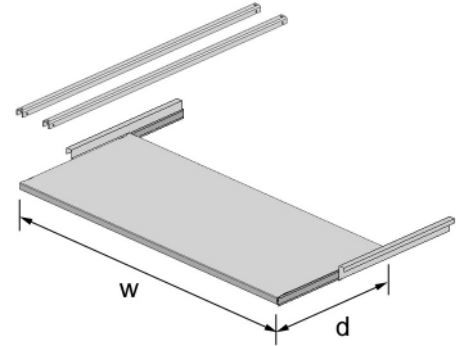

MEDIA TRAY

| | | | | | |
|------------|----|----|---|-----|----------|
| QS.MT16/36 | 36 | 16 | - | 4.0 | \$112.00 |
| QS.MT16/39 | 39 | 16 | - | 4.3 | \$118.00 |
| QS.MT16/42 | 42 | 16 | - | 4.4 | \$118.50 |
| QS.MT16/48 | 48 | 16 | - | 4.6 | \$153.00 |

- Use 16" deep media tray with 16" deep shelving

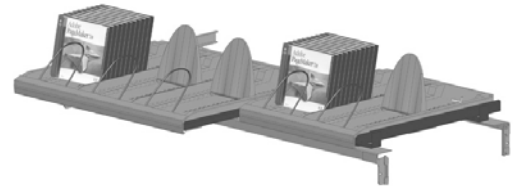

FINDABLE BOOK SUPPORT

| | | | | |
|-----------|---------------|---|-----|--------|
| QS.BKSP6 | Plain Base | 6 | 1.1 | \$6.00 |
| QS.BKSP9 | Plain Base | 9 | 1.5 | \$7.30 |
| QS.BKSPC6 | Cork Base | 6 | 1.1 | \$8.40 |
| QS.BKSPC9 | Cork Base | 9 | 1.5 | \$9.60 |
| QS.BKSPM6 | Magnetic Base | 6 | 1.1 | \$8.40 |
| QS.BKSPM9 | Magnetic Base | 9 | 1.5 | \$9.60 |

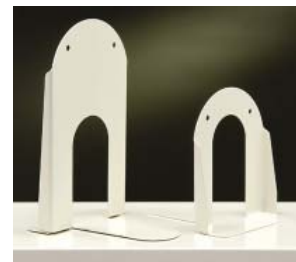

Notes :
 ** Available on QuickShip program (see **QuickShip** tab)

CODE # W D H lbs \$

FRONT STOP

| | | | | | |
|------------|----|---|---|-----|---------|
| QS.FRST/30 | 30 | - | 1 | 0.8 | \$11.50 |
| QS.FRST/36 | 36 | - | 1 | 1.0 | \$11.50 |
| QS.FRST/39 | 39 | - | 1 | 1.1 | \$11.80 |
| QS.FRST/42 | 42 | - | 1 | 1.2 | \$12.00 |
| QS.FRST/48 | 48 | - | 1 | 1.4 | \$12.75 |

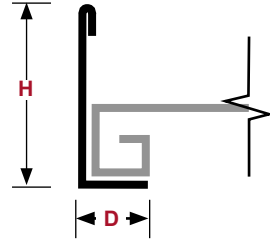

LABEL HOLDER

| | | | | | |
|-------|---|---|---|-----|--------|
| L5LHP | 5 | - | - | 0.1 | \$1.40 |
|-------|---|---|---|-----|--------|



RANGE FINDER

| | | | | | |
|-------|---|---|---|-----|---------|
| L2RFA | - | - | - | 0.1 | \$17.00 |
|-------|---|---|---|-----|---------|



CARD HOLDER

| | | | | | |
|-------|---|---|---|-----|--------|
| L2CHA | - | - | - | 0.4 | \$7.30 |
|-------|---|---|---|-----|--------|



| CODE # | W | D | H | lbs | \$ | |
|--------------|----------------|----|---|-----|------|----------|
| DOORS | | | | | | |
| 76" HIGH | QS.DRS/300.760 | 30 | - | 76 | 48.6 | \$785.00 |
| | QS.DRS/360.760 | 36 | - | 76 | 58.8 | \$811.00 |
| | QS.DRS/393.760 | 39 | - | 76 | 64.0 | \$825.00 |
| | QS.DRS/420.760 | 42 | - | 76 | 69.1 | \$837.00 |
| | QS.DRS/480.760 | 48 | - | 76 | 79.3 | \$863.00 |
| 85" HIGH | QS.DRS/300.850 | 30 | - | 85 | 52.9 | \$797.00 |
| | QS.DRS/360.850 | 36 | - | 85 | 64.2 | \$825.00 |
| | QS.DRS/393.850 | 39 | - | 85 | 69.9 | \$841.00 |
| | QS.DRS/420.850 | 42 | - | 85 | 75.6 | \$854.00 |
| | QS.DRS/480.850 | 48 | - | 85 | 86.9 | \$882.00 |
| 88" HIGH | QS.DRS/300.880 | 30 | - | 88 | 54.3 | \$800.00 |
| | QS.DRS/360.880 | 36 | - | 88 | 66.0 | \$831.00 |
| | QS.DRS/393.880 | 39 | - | 88 | 71.9 | \$846.00 |
| | QS.DRS/420.880 | 42 | - | 88 | 77.8 | \$860.00 |
| | QS.DRS/480.880 | 48 | - | 88 | 89.5 | \$889.00 |

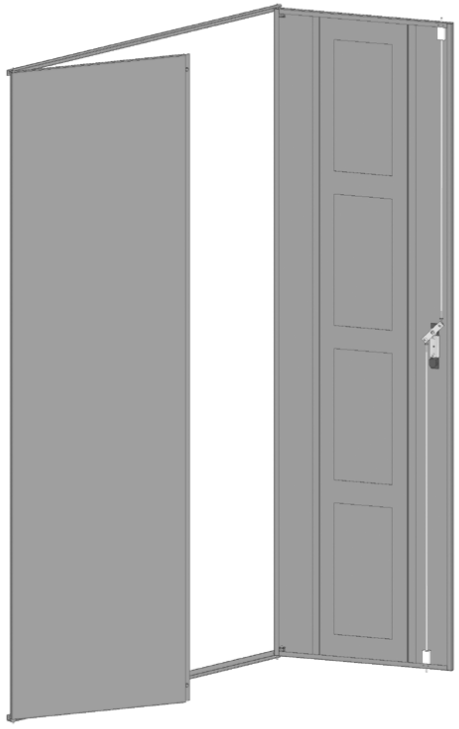

Notes :

- To order doors, choose the same height as the upright frame.
- Ex. : Doors **QS.DRS/360.760** require a SmartShelf frame **QS.RFRAME1/12.760**