

QUICKSHIP PROGRAM



ITEMS SHIPPED WITHIN 10 WORKING DAYS!
GUARANTEED!



Phone : 321-777-0464
Fax : 312-777-3539
Toll Free : 800-772-7562
E-Mail : aetnagsa@montel.com
Web : www.aetnastak.com

M MONTEL
AETNASTAK

QuadraMobile (Expandable and Modular Mobile System)_____	QS/3-QS/15
SmartShelf (4-Post Hybrid Shelving System)_____	QS/16-QS/21
Brep-1 (Periodical Display Cabinet)_____	QS/22

QUADRAMOBILE WITH SUPPORTED SMARTSHELF

Color : **Arctic White** C13.101.006

QUICKSHIP

CODE #	W	D	H	lbs	\$	
	Frame					
STARTER SECTION SINGLE FACE SHELVING - FIXED						
76" HIGH	QMSF.FSEQ763612	36	12	76	75.6	\$715.00
	QMSF.FSEQ763615	36	15	76	83.4	\$733.00
	QMSF.FSEQ764212	42	12	76	78.3	\$722.00
	QMSF.FSEQ764215	42	15	76	86.2	\$740.00
85" HIGH	QMSF.FSEQ853612	36	12	85	80.4	\$725.00
	QMSF.FSEQ853615	36	15	85	88.4	\$745.00
	QMSF.FSEQ854212	42	12	85	83.1	\$733.00
	QMSF.FSEQ854215	42	15	85	91.3	\$751.00
88" HIGH	QMSF.FSEQ883612	36	12	88	82.0	\$730.00
	QMSF.FSEQ883615	36	15	88	90.1	\$748.00
	QMSF.FSEQ884212	42	12	88	84.7	\$736.00
	QMSF.FSEQ884215	42	15	88	93.0	\$755.00

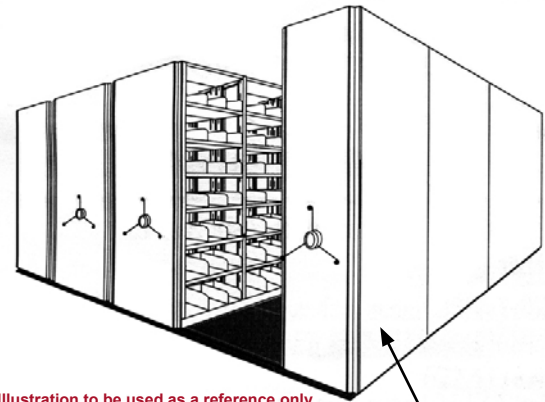

Illustration to be used as a reference only

Shelves and modular floor not included (see page **QS/16** for shelves and see page **QS/14** for floor)

STARTER

CODE #	W	D	H	lbs	\$	
STARTER SECTION SINGLE FACE SHELVING - MOBILE						
76" HIGH	QMSF.MSEQ763612	36	12	76	78.8	\$1,302.00
	QMSF.MSEQ763615	36	15	76	87.1	\$1,320.00
	QMSF.MSEQ764212	42	12	76	81.5	\$1,317.00
	QMSF.MSEQ764215	42	15	76	89.9	\$1,334.00
85" HIGH	QMSF.MSEQ853612	36	12	85	83.6	\$1,313.00
	QMSF.MSEQ853615	36	15	85	92.1	\$1,331.00
	QMSF.MSEQ854212	42	12	85	86.3	\$1,326.00
	QMSF.MSEQ854215	42	15	85	95.0	\$1,346.00
88" HIGH	QMSF.MSEQ883612	36	12	88	85.2	\$1,317.00
	QMSF.MSEQ883615	36	15	88	93.8	\$1,335.00
	QMSF.MSEQ884212	42	12	88	87.9	\$1,330.00
	QMSF.MSEQ884215	42	15	88	96.6	\$1,349.00

Components for a single face **starter** section

- 1 single carriage with bumper
- 1 front panel+handle including a safety locking pin (if required)
- 2 upright frames
- 1 canopy top

• Floor type locking device not included (see page **QS/14**)

Notes :

- Aluminium extrusions not available on QuickShip program
- Add 5" high for the overall height
- Maximum length = 12 feet
- 12" D and 24" D for **letter** size, 15" D and 30" D for **legal** size



Issued 06-01-2005

QS/3

QUADRAMOBILE WITH SUPPORTED SMARTSHELF

Color : **Arctic White** C13.101.006

QUICKSHIP

CODE #	W	D	H	lbs	\$	
	Frame					
STARTER DOUBLE FACE FULL DEPTH SHELVING - MOBILE						
76" HIGH	QMSF.MSEDQ763624	36	24	76	108.5	\$1,389.00
	QMSF.MSEDQ763630	36	30	76	124.1	\$1,425.00
	QMSF.MSEDQ764224	42	24	76	111.8	\$1,405.00
	QMSF.MSEDQ764230	42	30	76	127.8	\$1,442.00
85" HIGH	QMSF.MSEDQ853624	36	24	85	114.3	\$1,403.00
	QMSF.MSEDQ853630	36	30	85	130.6	\$1,440.00
	QMSF.MSEDQ854224	42	24	85	117.7	\$1,419.00
	QMSF.MSEDQ854230	42	30	85	134.2	\$1,457.00
88" HIGH	QMSF.MSEDQ883624	36	24	88	116.3	\$1,405.00
	QMSF.MSEDQ883630	36	30	88	139.1	\$1,467.00
	QMSF.MSEDQ884224	42	24	88	119.6	\$1,421.00
	QMSF.MSEDQ884230	42	30	88	142.8	\$1,484.00

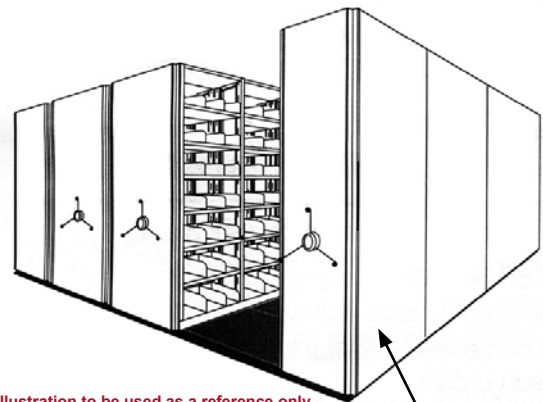

Illustration to be used as a reference only

Shelves and modular floor not included (see page **QS/16** for shelves and see page **QS/14** for floor)

STARTER

Components for a double face full depth **starter**

- 1 double carriage with bumper
- 1 front panel+handle including a safety locking pin
- 2 upright frames
- 1 canopy top

Notes :

- Aluminium extrusions not available on QuickShip program
- Add 5" high for the overall height
- Maximum length = 12 feet
- 12" D and 24" D for **letter** size, 15" D and 30" D for **legal** size

QS/4

Issued 06-01-2005

MONTEL AETNASTAK

GSA Schedule
Contract GS-28F-0017M

QUADRAMOBILE WITH SUPPORTED SMARTSHELF

Color : **Arctic White** C13.101.006

QUICKSHIP

CODE #	W	D	H	lbs	\$	
	Frame					
ADDER DOUBLE FACE FULL DEPTH SHELVING - MOBILE						
76" HIGH	QMSF.MAEDQ763624	36	24	76	52.1	\$536.00
	QMSF.MAEDQ763630	36	30	76	58.7	\$553.00
	QMSF.MAEDQ764224	42	24	76	55.4	\$553.00
	QMSF.MAEDQ764230	42	30	76	62.4	\$569.00
85" HIGH	QMSF.MAEDQ853624	36	24	85	53.7	\$539.00
	QMSF.MAEDQ853630	36	30	85	60.3	\$557.00
	QMSF.MAEDQ854224	42	24	85	57.0	\$556.00
	QMSF.MAEDQ854230	42	30	85	64.0	\$573.00
88" HIGH	QMSF.MAEDQ883624	36	24	88	54.2	\$541.00
	QMSF.MAEDQ883630	36	30	88	64.0	\$568.00
	QMSF.MAEDQ884224	42	24	88	57.5	\$557.00
	QMSF.MAEDQ884230	42	30	88	67.7	\$585.00

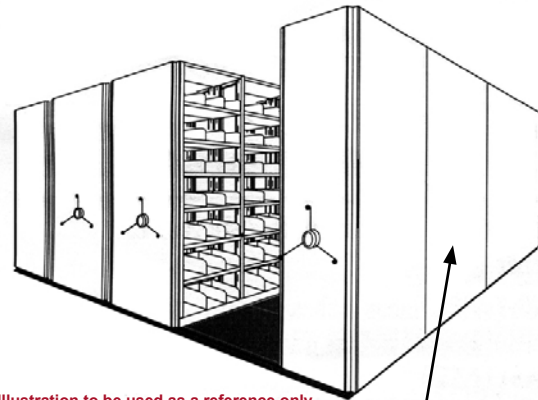

Illustration to be used as a reference only

Shelves and modular floor not included (see page **QS/16** for shelves and see page **QS/14** for floor)

ADDER

Components for a double face full depth **adder**

- 1 double carriage
- 1 upright frame
- 1 canopy top

Notes :

- Aluminium extrusions not available on QuickShip program
- Add 5" high for the overall height
- Maximum length = 12 feet
- 12" D and 24" D for **letter** size, 15" D and 30" D for **legal** size

QS/6

Issued 06-01-2005

MONTEL AETNASTAK

GSA Schedule
Contract GS-28F-0017M

QUADRAMOBILE WITH SUPPORTED SMARTSHELF

Color : **Arctic White** C13.101.006

QUICKSHIP

CODE #	W	D	H	lbs	\$	
	Frame					
STARTER SECTION SINGLE FACE SHELVING - FIXED						
76" HIGH	QMSB.FSEQ763612	36	12	76	75.6	\$715.00
	QMSB.FSEQ763615	36	15	76	83.4	\$733.00
	QMSB.FSEQ764212	42	12	76	78.3	\$722.00
	QMSB.FSEQ764215	42	15	76	86.2	\$740.00
85" HIGH	QMSB.FSEQ853612	36	12	85	80.4	\$725.00
	QMSB.FSEQ853615	36	15	85	88.4	\$745.00
	QMSB.FSEQ854212	42	12	85	83.1	\$733.00
	QMSB.FSEQ854215	42	15	85	91.3	\$751.00
88" HIGH	QMSB.FSEQ883612	36	12	88	82.0	\$730.00
	QMSB.FSEQ883615	36	15	88	90.1	\$748.00
	QMSB.FSEQ884212	42	12	88	84.7	\$736.00
	QMSB.FSEQ884215	42	15	88	93.0	\$755.00

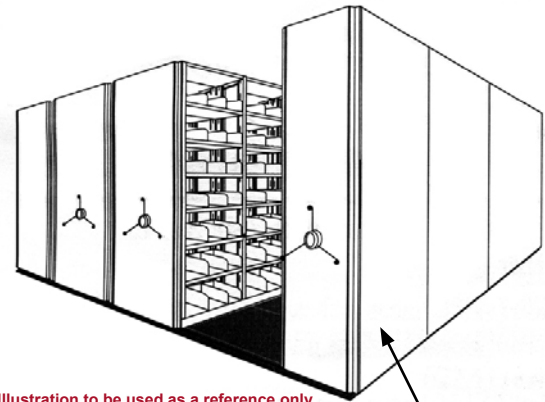

Illustration to be used as a reference only

Shelves and modular floor not included (see page **QS/16** for shelves and see page **QS/14** for floor)

STARTER

CODE #	W	D	H	lbs	\$	
STARTER SECTION SINGLE FACE SHELVING - MOBILE						
76" HIGH	QMSB.MSEQ763612	36	12	76	78.8	\$1,302.00
	QMSB.MSEQ763615	36	15	76	87.1	\$1,320.00
	QMSB.MSEQ764212	42	12	76	81.5	\$1,317.00
	QMSB.MSEQ764215	42	15	76	89.9	\$1,334.00
85" HIGH	QMSB.MSEQ853612	36	12	85	83.6	\$1,313.00
	QMSB.MSEQ853615	36	15	85	92.1	\$1,331.00
	QMSB.MSEQ854212	42	12	85	86.3	\$1,326.00
	QMSB.MSEQ854215	42	15	85	95.0	\$1,346.00
88" HIGH	QMSB.MSEQ883612	36	12	88	85.2	\$1,317.00
	QMSB.MSEQ883615	36	15	88	93.8	\$1,335.00
	QMSB.MSEQ884212	42	12	88	87.9	\$1,330.00
	QMSB.MSEQ884215	42	15	88	96.6	\$1,349.00

Components for a single face **starter** section

- 1 single carriage with bumper
- 1 front panel+handle including a safety locking pin (if required)
- 2 upright frames
- 1 canopy top

• Floor type locking device not included (see page **QS/14**)

Notes :

- Aluminium extrusions not available on QuickShip program
- Add 5" high for the overall height
- Maximum length = 12 feet
- 12" D and 24" D for **letter** size, 15" D and 30" D for **legal** size



Issued 06-01-2005

QS/7

QUADRAMOBILE WITH SUPPORTED SMARTSHELF

Color : **Arctic White** C13.101.006

QUICKSHIP

CODE #	W	D	H	lbs	\$	
	Frame					
STARTER DOUBLE FACE BACK-TO-BACK SHELVING - MOBILE						
76" HIGH	QMSB.MSEDQ763624	36	24	76	139.3	\$1,550.00
	QMSB.MSEDQ763630	36	30	76	155.0	\$1,582.00
	QMSB.MSEDQ764224	42	24	76	143.4	\$1,568.00
	QMSB.MSEDQ764230	42	30	76	159.4	\$1,601.00
85" HIGH	QMSB.MSEDQ853624	36	24	85	148.3	\$1,570.00
	QMSB.MSEDQ853630	36	30	85	164.6	\$1,604.00
	QMSB.MSEDQ854224	42	24	85	152.4	\$1,588.00
	QMSB.MSEDQ854230	42	30	85	169.0	\$1,622.00
88" HIGH	QMSB.MSEDQ883624	36	24	88	151.3	\$1,575.00
	QMSB.MSEDQ883630	36	30	88	167.8	\$1,611.00
	QMSB.MSEDQ884224	42	24	88	155.4	\$1,593.00
	QMSB.MSEDQ884230	42	30	88	172.2	\$1,630.00

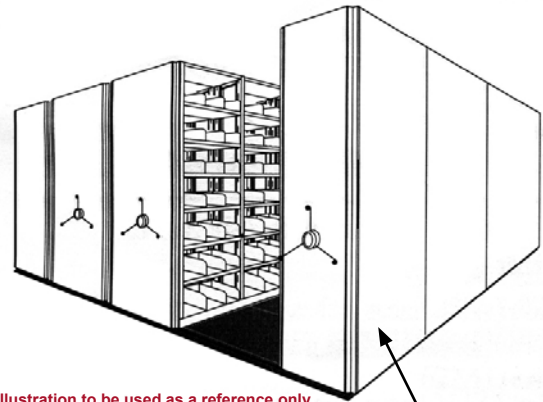

Illustration to be used as a reference only

Shelves and modular floor not included (see page **QS/16** for shelves and see page **QS/14** for floor)

STARTER

Components for a double face back-to-back **starter**

- 1 double carriage with bumper
- 1 front panel+handle including a safety locking pin
- 4 upright frames
- 2 canopy tops

Notes :

- Aluminium extrusions not available on QuickShip program
- Add 5" high for the overall height
- Maximum length = 12 feet
- 12" D and 24" D for **letter** size, 15" D and 30" D for **legal** size

QS/8

Issued 06-01-2005

MONTEL AETNASTAK

GSA Schedule
Contract GS-28F-0017M

QUADRAMOBILE WITH SUPPORTED SMARTSHELF

Color : **Arctic White** C13.101.006

QUICKSHIP

CODE #	W	D	H	lbs	\$	
	Frame					
ADDER SECTION SINGLE FACE SHELVING - FIXED						
76" HIGH	QMSB.FAEQ763612	36	12	76	38.4	\$384.00
	QMSB.FAEQ763615	36	15	76	41.9	\$392.00
	QMSB.FAEQ764212	42	12	76	41.1	\$390.00
	QMSB.FAEQ764215	42	15	76	44.8	\$398.00
85" HIGH	QMSB.FAEQ853612	36	12	85	41.0	\$388.00
	QMSB.FAEQ853615	36	15	85	44.5	\$395.00
	QMSB.FAEQ854212	42	12	85	43.7	\$393.00
	QMSB.FAEQ854215	42	15	85	47.4	\$402.00
88" HIGH	QMSB.FAEQ883612	36	12	88	40.3	\$389.00
	QMSB.FAEQ883615	36	15	88	43.9	\$397.00
	QMSB.FAEQ884212	42	12	88	43.0	\$395.00
	QMSB.FAEQ884215	42	15	88	46.7	\$403.00

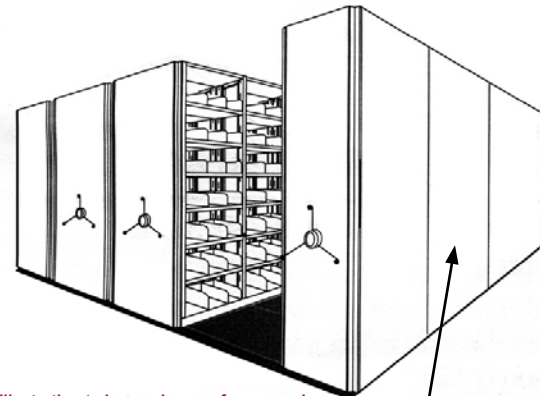

Illustration to be used as a reference only

Shelves and modular floor not included (see page **QS/16** for shelves and see page **QS/14** for floor)

ADDER

CODE #	W	D	H	lbs	\$	
ADDER SECTION SINGLE FACE SHELVING - MOBILE						
76" HIGH	QMSB.MAEQ763612	36	12	76	38.4	\$508.00
	QMSB.MAEQ763615	36	15	76	41.9	\$517.00
	QMSB.MAEQ764212	42	12	76	41.1	\$524.00
	QMSB.MAEQ764215	42	15	76	44.8	\$532.00
85" HIGH	QMSB.MAEQ853612	36	12	85	41.0	\$512.00
	QMSB.MAEQ853615	36	15	85	44.5	\$520.00
	QMSB.MAEQ854212	42	12	85	43.7	\$527.00
	QMSB.MAEQ854215	42	15	85	47.4	\$535.00
88" HIGH	QMSB.MAEQ883612	36	12	88	40.3	\$513.00
	QMSB.MAEQ883615	36	15	88	43.9	\$521.00
	QMSB.MAEQ884212	42	12	88	43.0	\$528.00
	QMSB.MAEQ884215	42	15	88	46.7	\$536.00

Components for a single face **adder** section

- 1 single carriage
- 1 upright frame
- 1 canopy top

Notes :

- Aluminium extrusions not available on QuickShip program
- Add 5" high for the overall height
- Maximum length = 12 feet
- 12" D and 24" D for **letter** size, 15" D and 30" D for **legal** size



Issued 06-01-2005

QS/9

QUADRAMOBILE WITH SUPPORTED SMARTSHELF

Color : **Arctic White** C13.101.006

QUICKSHIP

CODE #	W	D	H	lbs	\$	
	Frame					
ADDER DOUBLE FACE BACK-TO-BACK SHELVING - MOBILE						
76" HIGH	QMSB.MAEDQ763624	36	24	76	69.8	\$632.00
	QMSB.MAEDQ763630	36	30	76	76.4	\$648.00
	QMSB.MAEDQ764224	42	24	76	73.8	\$652.00
	QMSB.MAEDQ764230	42	30	76	80.8	\$667.00
85" HIGH	QMSB.MAEDQ853624	36	24	85	72.9	\$639.00
	QMSB.MAEDQ853630	36	30	85	79.5	\$655.00
	QMSB.MAEDQ854224	42	24	85	77.0	\$659.00
	QMSB.MAEDQ854230	42	30	85	83.9	\$674.00
88" HIGH	QMSB.MAEDQ883624	36	24	88	74.0	\$642.00
	QMSB.MAEDQ883630	36	30	88	80.6	\$658.00
	QMSB.MAEDQ884224	42	24	88	78.0	\$661.00
	QMSB.MAEDQ884230	42	30	88	85.0	\$676.00

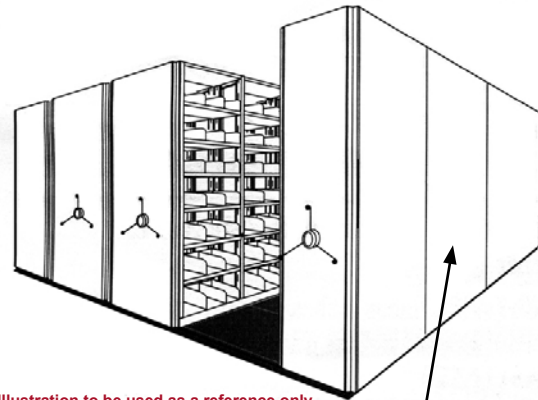

Illustration to be used as a reference only

Shelves and modular floor not included (see page **QS/16** for shelves and see page **QS/14** for floor)

ADDER

Components for a double face back-to-back **adders**

- 1 double carriage
- 2 upright frames
- 2 canopy tops

Notes :

- Aluminium extrusions not available on QuickShip program
- Add 5" high for the overall height
- Maximum length = 12 feet
- 12" D and 24" D for **letter** size, 15" D and 30" D for **legal** size

QS/10

Issued 06-01-2005

MONTEL AETNASTAK

GSA Schedule
Contract GS-28F-0017M

QUADRAMOBILE WITH HOOKED SMARTSHELF

Color : **Arctic White** C13.101.006

QUICKSHIP

CODE #	W	D	H	lbs	\$	
	Frame					
STARTER SECTION SINGLE FACE SHELVING - FIXED						
76" H	QMSH.FSEQ763612	36	12	76	86.8	\$730.00
	QMSH.FSEQ763615	36	15	76	97.5	\$749.00
85" H	QMSH.FSEQ853612	36	12	85	92.4	\$740.00
	QMSH.FSEQ853615	36	15	85	103.6	\$761.00
88" H	QMSH.FSEQ883612	36	12	88	94.2	\$744.00
	QMSH.FSEQ883615	36	15	88	105.7	\$764.00

CODE #	W	D	H	lbs	\$	
STARTER SECTION SINGLE FACE SHELVING - MOBILE						
76" H	QMSH.MSEQ763612	36	12	76	90.0	\$1,317.00
	QMSH.MSEQ763615	36	15	76	101.1	\$1,336.00
85" H	QMSH.MSEQ853612	36	12	85	95.6	\$1,328.00
	QMSH.MSEQ853615	36	15	85	107.3	\$1,347.00
88" H	QMSH.MSEQ883612	36	12	88	97.4	\$1,332.00
	QMSH.MSEQ883615	36	15	88	109.4	\$1,351.00

• Floor type locking device not included (see page **QS/14**)

CODE #	W	D	H	lbs	\$	
STARTER DOUBLE FACE BACK-TO-BACK SHELVING - MOBILE						
76" H	QMSH.MSEDQ763624	36	24	76	157.4	\$1,540.00
	QMSH.MSEDQ763630	36	30	76	179.0	\$1,574.00
85" H	QMSH.MSEDQ853624	36	24	85	168.2	\$1,560.00
	QMSH.MSEDQ853630	36	30	85	190.9	\$1,595.00
88" H	QMSH.MSEDQ883624	36	24	88	171.8	\$1,565.00
	QMSH.MSEDQ883630	36	30	88	194.8	\$1,602.00

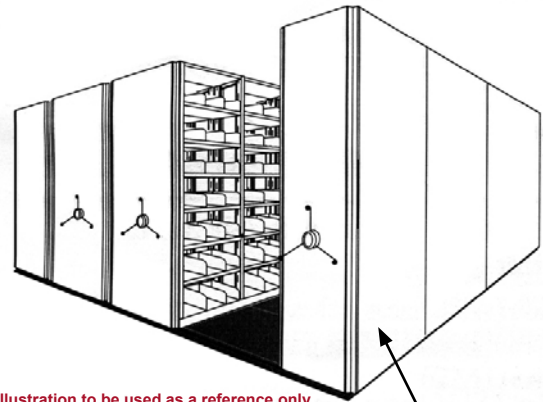

Illustration to be used as a reference only

STARTER

Shelves and modular floor not included (see page **QS/17** for shelves and see page **QS/14** for floor)

Components for a single face **starter** section

- 1 single carriage with bumper
- 1 front panel+handle including a safety locking pin (if required)
- 2 upright frames
- 1 canopy top

Components for a double face back-to-back **starter**

- 1 double carriage with bumper
- 1 front panel+handle including a safety locking pin
- 4 upright frames
- 2 canopy tops

Notes :

- Aluminium extrusions not available on QuickShip program
- Add 5" high for the overall height
- Maximum length = 12 feet
- 12" D and 24" D for **letter** size, 15" D and 30" D for **legal** size

QUADRAMOBILE WITH HOOKED SMARTSHELF

Color : **Arctic White** C13.101.006

QUICKSHIP

CODE #	W	D	H	lbs	\$
	Frame				
ADDER SECTION SINGLE FACE SHELVING - FIXED					
76" H QMSH.FAEQ763612	36	12	76	38.9	\$365.00
76" H QMSH.FAEQ763615	36	15	76	43.0	\$374.00
85" H QMSH.FAEQ853612	36	12	85	40.5	\$369.00
85" H QMSH.FAEQ853615	36	15	85	44.6	\$377.00
88" H QMSH.FAEQ883612	36	12	88	41.0	\$370.00
88" H QMSH.FAEQ883615	36	15	88	45.1	\$378.00

CODE #	W	D	H	lbs	\$
ADDER SECTION SINGLE FACE SHELVING - MOBILE					
76" H QMSH.MAEQ763612	36	12	76	38.9	\$489.00
76" H QMSH.MAEQ763615	36	15	76	43.0	\$499.00
85" H QMSH.MAEQ853612	36	12	85	40.5	\$493.00
85" H QMSH.MAEQ853615	36	15	85	44.6	\$502.00
88" H QMSH.MAEQ883612	36	12	88	41.0	\$494.00
88" H QMSH.MAEQ883615	36	15	88	45.1	\$503.00

CODE #	W	D	H	lbs	\$
ADDER DOUBLE FACE BACK-TO-BACK SHELVING - MOBILE					
76" H QMSH.MAEDQ763624	36	24	76	71.0	\$594.00
76" H QMSH.MAEDQ763630	36	30	76	79.4	\$612.00
85" H QMSH.MAEDQ853624	36	24	85	74.1	\$601.00
85" H QMSH.MAEDQ853630	36	30	85	82.6	\$619.00
88" H QMSH.MAEDQ883624	36	24	88	75.2	\$604.00
88" H QMSH.MAEDQ883630	36	30	88	83.6	\$636.00

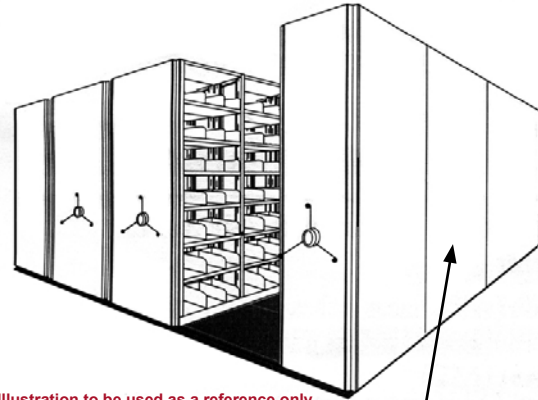

Illustration to be used as a reference only

Shelves and modular floor not included (see page **QS/17** for shelves and see page **QS/14** for floor)

ADDER

Components for a single face **adder** section

- 1 single carriage
- 1 upright frame
- 1 canopy top

Components for a double face back-to-back **adder**

- 1 double carriage
- 2 upright frames
- 2 canopy tops

Notes :

- Aluminium extrusions not available on QuickShip program
- Add 5" high for the overall height
- Maximum length = 12 feet
- 12" D and 24" D for **letter** size, 15" D and 30" D for **legal** size

QS/12

Issued 06-01-2005

MONTEL AETNASTAK

GSA Schedule
Contract GS-28F-0017M

QUADRAMOBILE WITH SMARTSHELF 4-POST SHELVING

Color : **Arctic White** C13.101.006

QUICKSHIP

	CODE #				W	D	H	lbs	\$
	LEFT	CENTER	RIGHT	SINGLE					
	312.101/	312.100/	312.103/	312.102/					
	STEEL BACK PANELS - SINGLE FACE								
76" H	365.076	360.076	365.076	372.076	36	-	76	33.0	\$203.00
	425.076	420.076	425.076	432.076	42	-	76	38.0	\$215.00
85" H	365.085	360.085	365.085	372.085	36	-	88	36.6	\$213.60
	425.085	420.085	425.085	432.085	42	-	88	42.3	\$227.40
88" H	365.088	360.088	365.088	372.088	36	-	88	37.9	\$215.00
	425.088	420.088	425.088	432.088	42	-	88	43.7	\$228.00

	CODE #	W	D	H	lbs	\$
	STEEL BACK PANELS - DOUBLE FACE					
76" H	QS.FBP/360.076	36	-	76	31.3	\$192.00
	QS.FBP/420.076	42	-	76	36.2	\$225.00
85" H	QS.FBP/360.085	36	-	85	35.0	\$210.00
	QS.FBP/420.085	42	-	85	40.4	\$247.00
88" H	QS.FBP/360.088	36	-	88	36.2	\$220.00
	QS.FBP/420.088	42	-	88	41.8	\$258.00

	STEEL END PANELS					
76" HIGH	240.139/120.076	-	12	76	16.1	\$92.30
	240.139/150.076	-	15	76	18.6	\$96.00
	240.145/240.076	-	24	76	26.3	\$159.00
	240.145/300.076	-	30	76	29.0	\$165.40
85" HIGH	240.139/120.085	-	12	85	17.7	\$98.30
	240.139/150.085	-	15	85	20.5	\$102.70
	240.145/240.085	-	24	85	31.4	\$170.90
	240.145/300.085	-	30	85	34.6	\$178.70
88" HIGH	240.139/120.088	-	12	88	18.2	\$100.30
	240.139/150.088	-	15	88	22.1	\$104.90
	240.145/240.088	-	24	88	33.1	\$174.90
	240.145/300.088	-	30	88	36.5	\$183.10

Notes :
 • Items on this page cannot be ordered separately



Issued 06-01-2005

QS/13

QUADRAMOBILE WITH SMARTSHELF 4-POST SHELVING

Color : **Arctic White** C13.101.006

QUICKSHIP

TOTAL length
Modular False
Floor

Qty of
floor
34" Wide

Qty of
floor
56" Wide

Qty of
floor
76" Wide

34"	1		
56"		1	
68"	2		
76"			1
90"	1	1	
102"	3		
110"	1		1
112"		2	
124"	2	1	
132"		1	1
136"	4		
144"	2		1
146"	1	2	
152"			2
158"	3	1	
166"	1	1	1
168"		3	
170"	5		
178"	3		1
180"	2	2	
186"	1		2
188"		2	1
192"	4	1	
200"	2	1	1
202"	1	3	
204"	6		
208"		1	2
212"	4		1
214"	3	2	
220"	2		2
222"	1	2	1

TOTAL length
Modular False
Floor

Qty of
floor
34" Wide

Qty of
floor
56" Wide

Qty of
floor
76" Wide

224"		4	
226"	5	1	
228"			3
234"	3	1	1
236"	2	3	
238"	7		
242"	1	1	2
244"		3	1
246"	5		1
248"	4	2	
254"	3		2
256"	2	2	1
258"	1	4	
260"	6	1	
262"	1		3
264"		2	2
268"	4	1	1
270"	3	3	
272"	8		
276"	2	1	2
280"		5	
282"	5	2	
284"		1	3
288"	4		2
290"	3	2	1
292"	2	4	
294"	7	1	
296"	2		3
298"	1	2	2
300"		4	1

QS/14

Issued 06-01-2005

MONTEL AETNASTAK

GSA Schedule
Contract QS-28F-0117M

QUADRAMOBILE WITH SMARTSHELF 4-POST SHELVING

Color : **Arctic White** C13.101.006

QUICKSHIP

CODE # W D H lbs \$

MODULAR FLOOR FOR A STARTER SECTION

QMPS3436	36	34	-	30.2	\$345.10
QMPS3442	42	34	-	34.0	\$348.50
QMPS5636	36	56	-	49.8	\$568.40
QMPS5642	42	56	-	56.0	\$574.00
QMPS7636	36	76	-	67.6	\$771.40
QMPS7642	42	76	-	76.0	\$779.00

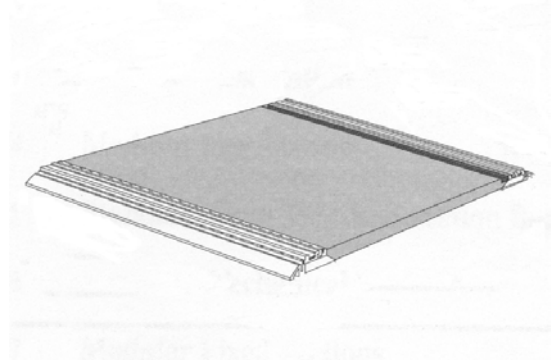

MODULAR FLOOR FOR A ADDER SECTION

QMPA3436	36	34	-	23.8	\$263.50
QMPA3442	42	34	-	30.6	\$287.30
QMPA5636	36	56	-	39.2	\$434.00
QMPA5642	42	56	-	50.4	\$473.20
QMPA7636	36	76	-	53.2	\$589.00
QMPA7642	42	76	-	68.4	\$642.20

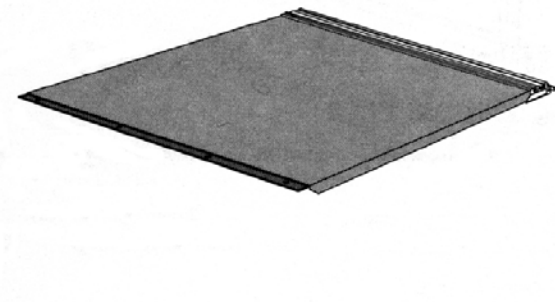

FLOOR TYPE LOCKING DEVICE

QMQLLOCK	-	-	40	5.4	\$175.00
----------	---	---	----	-----	-----------------



SMARTSHELF 4-POST HYBRID SHELVING SYSTEM

Color : **Arctic White** C13.101.006

QUICKSHIP

	CODE #	W	D	H	lbs	\$
76" HIGH	UPRIGHT FRAME					
	QS.RFRAME1/12.760	-	12	76	17.6	\$65.90
	QS.RFRAME1/15.760	-	15	76	18.6	\$68.00
	QS.RFRAME1/24.760	-	24	76	21.2	\$74.30
	QS.RFRAME1/30.760	-	30	76	23.6	\$80.60
85" HIGH	QS.RFRAME1/12.850	-	12	85	19.3	\$69.30
	QS.RFRAME1/15.850	-	15	85	20.2	\$71.40
	QS.RFRAME1/24.850	-	24	85	22.8	\$77.70
	QS.RFRAME1/30.850	-	30	85	25.2	\$84.00
88" HIGH	QS.RFRAME1/12.880	-	12	88	19.9	\$70.50
	QS.RFRAME1/15.880	-	15	88	20.7	\$72.60
	QS.RFRAME1/24.880	-	24	88	23.3	\$78.90
	QS.RFRAME2/30.880	-	30	88	25.7	\$85.20

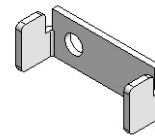
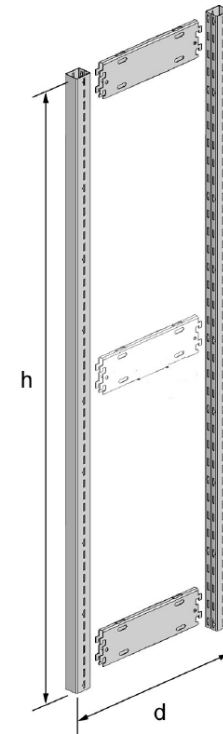

BRACKET FOR UPRIGHT

QS.UB	-	-	-	0.1	\$4.00
-------	---	---	---	-----	---------------

- Use this bracket with the back-to-back shelving only

SWAY BRACE - SINGLE FACE

QS.XSBST1/36	36	-	-	3.1	\$33.90
--------------	----	---	---	-----	----------------

- Use this sway brace with frame 72"H and higher

SWAY BRACE - DOUBLE FACE

QS.XSBDT1/36	36	-	-	3.7	\$35.40
--------------	----	---	---	-----	----------------

- Use this sway brace with frame 72"H and higher

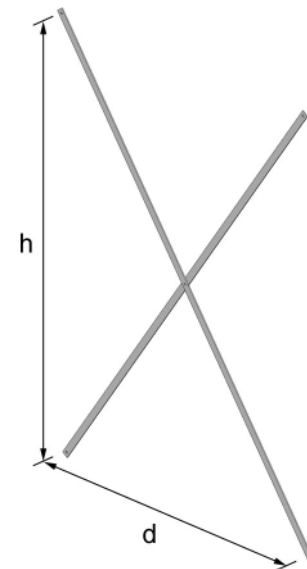

QS/16

Issued 06-01-2005

MONTEL AETNASTAK

GSA Schedule
Contract QS-28F-0017M

SMARTSHELF 4-POST HYBRID SHELVING SYSTEM

Color : Arctic White C13.101.006

QUICKSHIP

	CODE #	W	D	r*	lbs	\$
36" WIDE	<u>PLAIN SUPPORTED SHELF ASSEMBLY</u>					
	QS3612SFA	36	12	-	7.6	\$43.30
	QS3615SFA	36	15	-	8.6	\$45.70
	QS3624DFA	36	24	1	12.8	\$58.20
	QS3630DFA	36	30	2	16.6	\$69.50
42" WIDE	QS4212SFA	42	12	-	8.8	\$46.70
	QS4215SFA	42	15	-	9.9	\$49.50
	QS4224DFA	42	24	2	15.8	\$68.50
	QS4230DFA	42	30	2	18.8	\$75.20
36" WIDE	<u>SLOTTED SUPPORTED SHELF ASSEMBLY</u>					
	QSS3612SFA	36	12	-	7.6	\$43.70
	QSS3615SFA	36	15	-	8.6	\$46.00
	QSS3624DFA	36	24	1	12.8	\$58.50
	QSS3630DFA	36	30	2	16.6	\$69.80
42" WIDE	QSS4212SFA	42	12	-	8.8	\$47.10
	QSS4215SFA	42	15	-	9.9	\$49.80
	QSS4224DFA	42	24	2	15.8	\$68.90
	QSS4230DFA	42	30	2	18.8	\$75.50
36" WIDE	<u>CANOPY TOP SUPPORTED SHELF ASSEMBLY</u>					
	QST3612SFA	36	12	-	9.0	\$43.40
	QST3615SFA	36	15	-	10.0	\$45.70
	QST3624SFA	36	24	-	12.8	\$52.80
	QST3630SFA	36	30	-	14.7	\$57.50
42" WIDE	QST4212SFA	42	12	-	10.4	\$46.70
	QST4215SFA	42	15	-	11.5	\$49.50
	QST4224SFA	42	24	-	14.8	\$57.70
	QST4230SFA	42	30	-	17.0	\$63.20

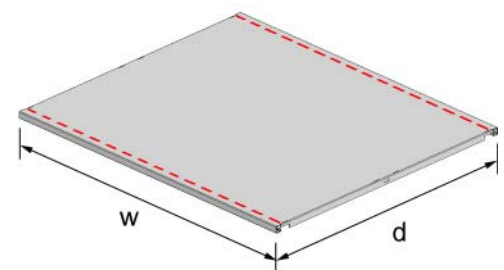
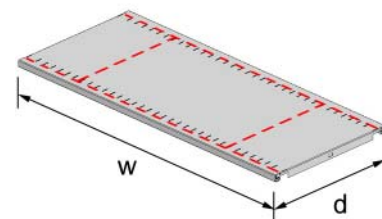
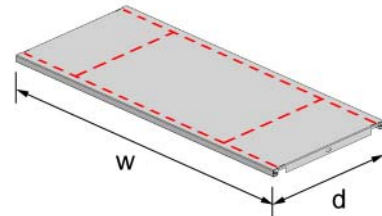

Notes :

- 4-bend 3/4" thick shelf
- 22 gauge
- Two shelf supports and necessary reinforcements included
- r* Quantity of shelf reinforcements included per assembly

SMARTSHELF 4-POST HYBRID SHELVING SYSTEM

Color : **Arctic White** C13.101.006

QUICKSHIP

CODE #	W	D	r*	lbs	\$
<u>PLAIN HOOKED SHELF ASSEMBLY</u>					
36" W QS3612SHA	36	12	-	7.7	\$24.30
36" W QS3615SHA	36	15	-	9.2	\$27.70

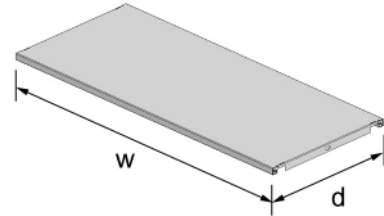

<u>SLOTTED HOOKED SHELF ASSEMBLY</u>					
36" W QSS3612SHA	36	12	-	7.7	\$24.70
36" W QSS3615SHA	36	15	-	9.2	\$28.10

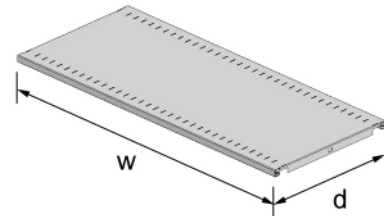

<u>CANOPY TOP HOOKED SHELF ASSEMBLY</u>					
36" W QST3612SHA	36	12	-	6.6	\$24.30
36" W QST3615SHA	36	15	-	8.2	\$27.70

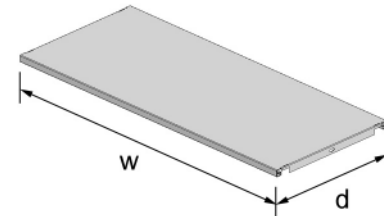

Notes :

- 4-bend 3/4" thick shelf
- 18 gauge
- 4 aluminium hooks and necessary reinforcements included
- r* Quantity of shelf reinforcements included per assembly

QS/18

Issued 06-01-2005

MONTEL AETNASTAK

GSA Schedule
Contract QS-28F-0117M

SMARTSHELF 4-POST HYBRID SHELVING SYSTEM

Color : **Arctic White** C13.101.006

QUICKSHIP

CODE # W D H lbs \$

PLAIN BACKSTOP (for single face section)

QS.SBSNS/36	36	3/8	5 1/2	2.3	\$11.10
QS.SBSNS/42	42	3/8	5 1/2	2.6	\$12.00

SLOTTED BACKSTOP (for single face section)

QS.SBS/36	36	3/8	5 1/2	2.3	\$11.30
QS.SBS/42	42	3/8	5 1/2	2.6	\$12.20

PLAIN CENTERSTOP (for double face full depth section)

QS.SBFNS/36	36	3/4	4 1/2	2.3	\$10.80
QS.SBFNS/42	42	3/4	4 1/2	2.6	\$11.70

SLOTTED CENTERSTOP (for double face full depth section)

QS.SBF/36	36	3/4	4 1/2	2.3	\$10.90
QS.SBF/42	42	3/4	4 1/2	2.6	\$11.90

- Only one backstop or centerstop per shelf (if required)

DIVIDER

QS.DIV6/12	-	12	6	0.7	\$3.00
QS.DIV6/15	-	15	6	0.9	\$3.50

- Actual depth of divider is 1" less than the actual shelf depth. Ex. : **15" shelf = 14" divider**

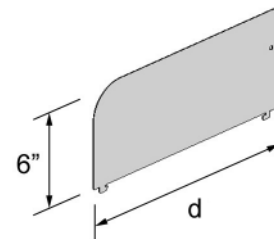
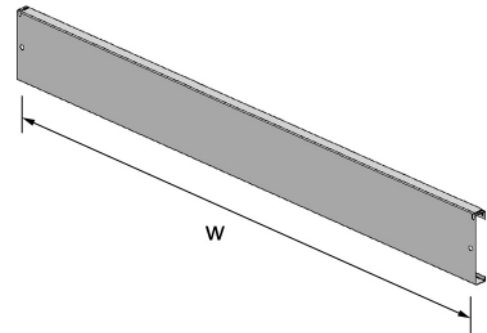
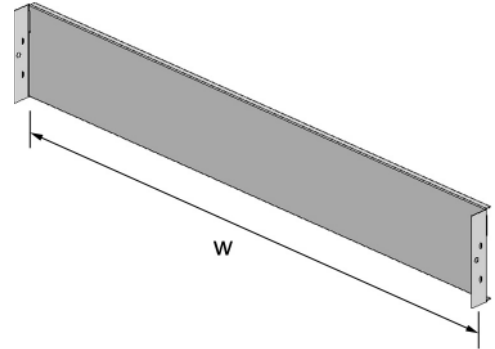

SMARTSHELF 4-POST HYBRID SHELVING SYSTEM

Color : **Arctic White** C13.101.006

QUICKSHIP

CODE # W D H lbs \$

SLIDING REFERENCE SHELF FOR SUPPORTED SHELVING

QS.BRESQ3012/12	30	12	1	10.0	\$108.50
QS.BRESQ3015/15	30	15	1	10.5	\$112.00
QS.BRESQ3012/24	30	12	1	11.2	\$111.50
QS.BRESQ3015/30	30	15	1	12.2	\$115.00

- The last 2 characters in QS.BRESQ2412/**12**, **12** refers to the depth of the section
- Two shelf reinforcements included with each sliding reference shelf

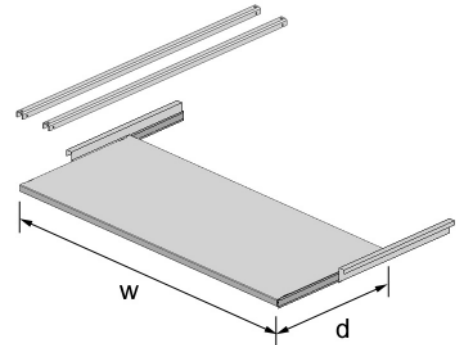

SLIDING REFERENCE SHELF FOR HOOKED SHELVING

QS.BREHQ3012	30	12	1	12.0	\$101.00
QS.BREHQ3015	30	15	1	15.0	\$106.00

KICK STRIP / FRONT BASE FOR SUPPORTED SHELVING
(see below)

QS.SKICK3/36	36	-	3	6.0	\$16.30
QS.SKICK3/42	42	-	3	7.0	\$18.50

KICK STRIP / FRONT BASE FOR HOOKED SHELVING

QS.KICK3/36	36	-	3	6.0	\$16.30
QS.KICK3/42	42	-	3	7.0	\$18.50

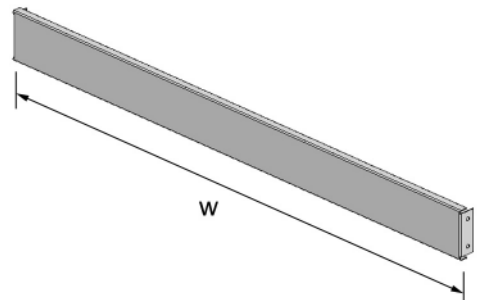

BASE SHELF REPLACEMENT KIT

QS.SHL2X/36	36	-	-	0.0	\$0.00
QS.SHL2X/42	42	-	-	0.0	\$0.00

- Two base shelf supports are included in each kit
- Required to install a base shelf at less than 1 1/2" from the floor. This kit replaces the two shelf supports included in the shelf assembly by two base shelf supports

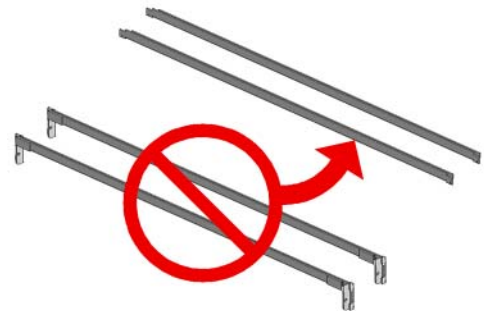

LEVELERS

QS.GLIDE	-	-	-	0.2	\$9.50
----------	---	---	---	-----	---------------

- Add a minimum of 1/2" high to the overall height of the system
- Leveler allows 3/4" high adjustment

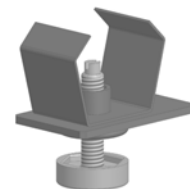

QS/20

Issued 06-01-2005

MONTEL AETNASTAK

GSA Schedule
Contract QS-28F-0117M

SMARTSHELF 4-POST HYBRID SHELVING SYSTEM

Color : **Arctic White** C13.101.006

QUICKSHIP

CODE #	W D H lbs				\$		
	LEFT	CENTER	RIGHT	SINGLE			
<i>QS.BPL/ QS.BPC/ QS.BPR/ QS.BPU/</i>							
STEEL BACK PANELS - SINGLE FACE							
76" H	365.076	360.076	365.076	372.076	36 - 76	31.3	\$192.00
	425.076	420.076	425.076	432.076	42 - 76	36.2	\$225.00
85" H	365.085	360.085	365.085	372.085	36 - 88	35.0	\$210.00
	425.085	420.085	425.085	432.085	42 - 88	40.4	\$247.00
88" H	365.088	360.088	365.088	372.088	36 - 88	36.2	\$220.00
	425.088	420.088	425.088	432.088	42 - 88	41.8	\$258.00

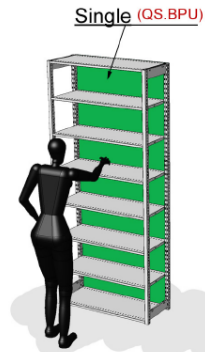

CODE #	W D H lbs				\$	
	LEFT	CENTER	RIGHT	SINGLE		
STEEL BACK PANELS - DOUBLE FACE						
76" H	QS.FBP/360.076	36	-	76	31.3	\$192.00
	QS.FBP/420.076	42	-	76	36.2	\$225.00
85" H	QS.FBP/360.085	36	-	85	35.0	\$210.00
	QS.FBP/420.085	42	-	85	40.4	\$247.00
88" H	QS.FBP/360.088	36	-	88	36.2	\$220.00
	QS.FBP/420.088	42	-	88	41.8	\$258.00

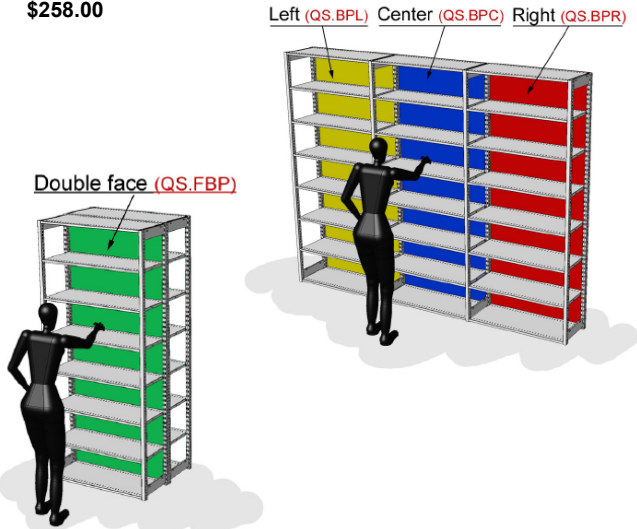

CODE #	W D H lbs				\$	
	LEFT	CENTER	RIGHT	SINGLE		
STEEL FRONT OR END PANELS						
76" HIGH	QS.EP/122.076	-	12	76	14.5	\$139.00
	QS.EP/152.076	-	15	76	17.0	\$144.00
	QS.EP/242.076	-	24	76	24.6	\$168.00
	QS.EP/302.076	-	30	76	29.6	\$179.00
85" HIGH	QS.EP/122.085	-	12	85	16.1	\$142.00
	QS.EP/152.085	-	15	85	18.9	\$149.00
	QS.EP/242.085	-	24	85	27.3	\$174.00
	QS.EP/302.085	-	30	85	32.9	\$187.00
88" HIGH	QS.EP/122.088	-	12	88	16.7	\$144.00
	QS.EP/152.088	-	15	88	19.6	\$150.00
	QS.EP/242.088	-	24	88	28.2	\$176.00
	QS.EP/302.088	-	30	88	34.0	\$189.00



Notes :
 • Items on this page cannot be ordered separately



Issued 06-01-2005

QS/21

BREP-1 PERIODICAL DISPLAY CABINET

Color : Arctic White C13.101.006

QUICKSHIP

CODE #	W	D	H	Qty Hinged Shelves	Qty Plain Shelves	lbs	\$
--------	---	---	---	--------------------------	-------------------------	-----	----

BREP-1	37 1/2	17 1/2	72	5	5	206.0	\$1,218.00
--------	--------	--------	----	---	---	-------	------------

• Pre-assembled at the factory

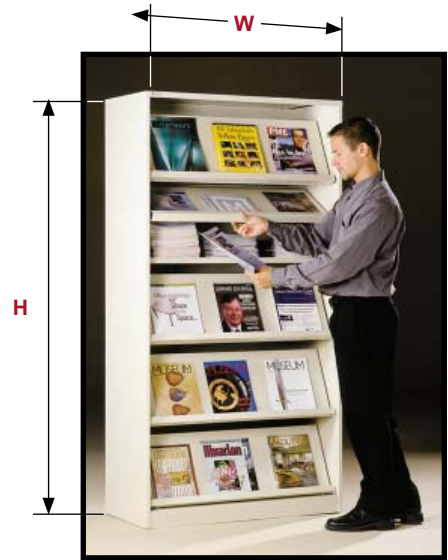

QS/22

Issued 06-01-2005

MONTEL AETNASTAK

GSA Schedule
Contract QS-28F-0117M